

*Power Sources for Remote Arctic  
Applications*

June 1994

OTA-BP-ETI-129  
NTIS order #PB94-193232

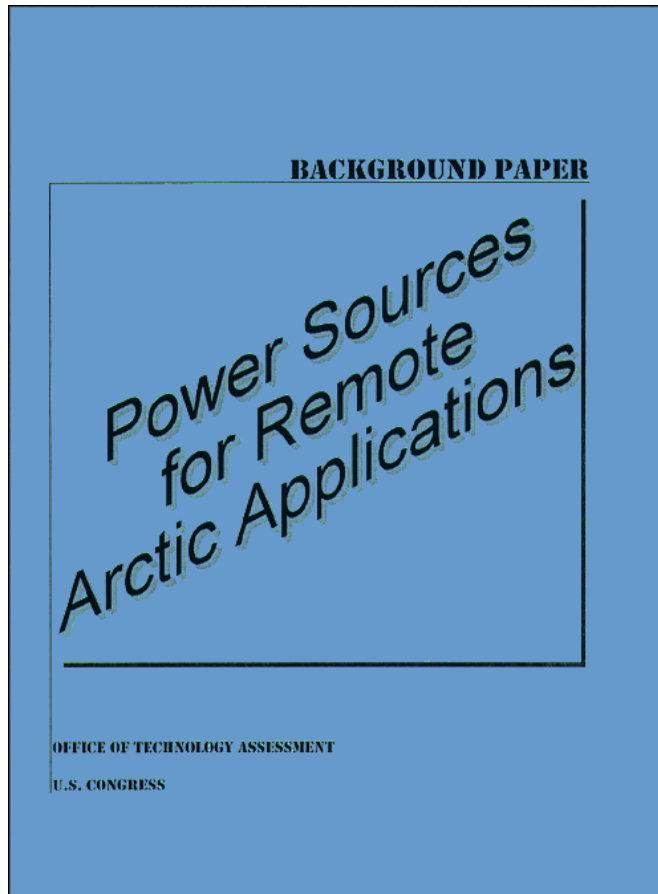

**Recommended Citation:** U.S. Congress, Office of Technology Assessment,  
*Power Sources for Remote Arctic Applications, OTA-BP-ETI 129*  
(Washington, DC: June 1994).

# Foreword

The U.S. Air Force operates a seismic observatory at Burnt Mountain, Alaska to assist in nuclear treaty verification. This unattended station --consisting of five sites clustered within a 1.5 mile radius--is located in a remote area north of the Arctic Circle, approximately 50 miles from the nearest villages. The seismic monitoring and data communications equipment at the station require low, but very reliable, power. Currently, the power comes from 10 radioisotope thermoelectric generators (RTGs), each containing between 1.2 and 3.9 pounds of Strontium 90, a highly radioactive material.

In August and September 1992, a tundra fire at Burnt Mountain damaged some of the data cables connecting the sites. Though the fire did not impinge on the monitoring, communications, and power equipment at the sites, it raised public concern among the nearby populations about the safety of using radioactive material as the power source at the sites. Senators Stevens and Murkowski of Alaska asked OTA to evaluate alternative power technologies for the site. Senator Stevens is a member of the Senate Committee on Commerce, Science, and Technology, among others; Senator Murkowski is a member of the Senate Committee on Energy and Natural Resources, among others. OTA examined the safety of the RTGs at Burnt Mountain and assessed the viability and risks of two alternative power sources--thermoelectric generators and photovoltaic (PV) systems--for the station.

This background paper concludes that continued use of the RTGs at Burnt Mountain entails low risk for the safety of maintenance workers and local populations and for the environment. Installation of lightning protection devices and intrusion detection devices at the station would lower the risk further still. If the RTGs were required to be removed immediately, the only viable replacement power source would be a propane-fueled thermoelectric generator system. The principle risk of this type of system is the transport and storage of the roughly 5,000 pounds of propane that would be needed each year. If the RTGs could be tolerated at site for three or four more years or longer, other power technologies may prove feasible. At present, a PV system appears to be the most viable nonfuel power source. A PV prototype system would need to be tested at the site to prove the technology's cold weather and low sunlight performance. The safety and environmental risk of using PV system at the site is possible release of toxic fumes and heavy metals from the batteries.

OTA appreciates the assistance received from several individuals and organizations in the course of this study. To all of them goes the gratitude of OTA and the personal thanks of the project staff.

ROGER C. HERDMAN  
Director

# **P**reject Staff

**Peter D. Blair**

Assistant Director  
Industry, Commerce, and Inter-  
national Security Division

**Emilia L. Govan**

Program Director  
Energy, Transportation, and  
Infrastructure Program

**PRINCIPAL STAFF**

**John E. Newman**

Project Director (beginning  
August 1993)

**Joe Raguso**

Project Director (until August  
1993)

**CONTRACTOR**

Future Resources Associates, Inc.

**ADMINISTRATIVE STAFF**

**Lillian Chapman**

Division Administrator

**Marsha Fenn**

Technical Editor

**Tina Aikens**

Administrative Secretary

**Gay Jackson**

PC Specialist

# **R**eviewers

**Mohamad Ali Azarm**  
Brookhaven National Laboratory

**Steven L. Baggett**  
U.S. Nuclear Regulatory Commission

**Samuel Baldwin**  
Office of Technology Assessment

**Thomas Cochran**  
Natural Resources Defense Council

**Gerald Epstein**  
Office of Technology Assessment

**Tony Fainberg**  
office of Technology Assessment

**Lois Joellenbeck**  
Office of Technology Assessment

**Peter Johnson**  
Office of Technology Assessment

**Thomas Lamp**  
Wright Laboratory  
U.S. Air Force

**Charles E. Mayer**  
School of Engineering  
University of Alaska - Fairbanks

**Stan Read**  
Alaska Department of  
Environmental Conservation

**German Reyes**  
Office of Technology Assessment

**George H. Rothe**  
U.S. Air Force Technical  
Applications Center

**John F. Vogt**  
Teledyne Brown Engineering-  
Energy Systems

**Matthew Weinberg**  
Office of Technology Assessment

# Contents

## **Chapter 1- Summary 1**

Air Force Findings 2

OTA Findings 3

Conclusions 5

## **Chapter 2- Background 7**

Equipment and Operations 8

Radioisotope Thermoelectric Generators 11

Strontium-90 Fuel 12

Location and Climate 13

## **Chapter 3- Evaluation Criteria 17**

Reliability 17

Safety and Environment 18

**Cost 18**

## **Chapter 4- Power Source Equipment: Cost and Reliability 19**

Radioisotope Thermoelectric Generators 19

Propane-Fueled Thermoelectric Generators 20

Photovoltaics 23

    Stand-Alone PV Power System (PV/Battery) 26

    Hybrid Power System (PV/TEG) 27

    Reliability 27

Summary of Costs and Reliability 28

## **Chapter 5- Power Source Equipment: Safety and Environmental Assessment 31**

Radioisotope Thermoelectric Generators 31

    Licenses and Emergency Plans 32

    Accident Scenarios 34

Propane-Fueled Thermoelectric Generators 37

    Accident Scenarios 38

Photovoltaics 39

Conclusions 39

*(Continued on page vii)*

*(Continued from page vi)*

## **Figures**

- Figure 1-1 Timeline of Power Options for the Burnt Mountain Seismic Observatory 4
- Figure 2-1 Layout of Burnt Mountain Seismic Observatory Showing Distances Between Equipment 9
- Figure 2-2 Configuration and Measured Power Requirements of Equipment at Burnt Mountain Seismic Observatory 10
- Figure 2-3 Map of Alaska Showing the Location of the Burnt Mountain Seismic Observatory and Nearby Communities 14
- Figure 4-1 Schematic of a Typical RTG Used for Terrestrial Applications 21
- Figure 4-2 Solar Balance for a Hypothetical PV Array in an Arctic Location 25

## **Tables**

- Table 2-1 RTG Models, Power Demand, and Estimated Replacement Dates 12
- Table 2-2 Climate Conditions at Fort Yukon 15
- Table 4-1 Characteristics of the RTGs at Burnt Mountain 22
- Table 4-2 Examples of Photovoltaic Power Systems Used in Cold Regions 24
- Table 4-3 Summary of Costs of TEG and PV Power Sources as Estimated by the Air Force 29

## **Appendix A - Acronyms 42**

# Summary | 1

**T**he U.S. Air Force operates a seismic observatory on Burnt Mountain in Alaska to help verify compliance with nuclear test ban treaties. Data from the unattended station, located in a remote area about 60 miles north of the Arctic Circle, are used to ascertain whether or not seismic activity has been caused by nuclear explosions. The data collection and communications equipment at the station is powered by 10 nuclear batteries, called radioisotope thermoelectric generators (RTGs). Each RTG is fueled with between 1.2 and 3.9 pounds of strontium-90 (Sr-90), a highly radioactive material. RTGs are used because of their high reliability and low maintenance requirements.

In August and September 1992, a tundra fire encroached on the Burnt Mountain site. It damaged some data cables, but did not disturb the monitoring, communications, and power equipment. The fire raised public concern among nearby inhabitants about the safety of using a radioactive material as the power source at the station. To address this concern, Senator Murkowski of Alaska asked the Air Force to inspect the site, conduct public meetings to discuss the risks and advantages of RTGs, and analyze alternative potential power sources for the station. Additionally, Senator Stevens of Alaska along with Senator Murkowski requested that the Office of Technology Assessment (OTA) undertake an independent evaluation of alternative power technologies for the site. The objective of the assessment was to identify a remote power source technology that presents the lowest health and safety risk to nearby populations and equipment technicians at an acceptable life-cycle cost. The Senators' letter stated specifically that the health, safety, and environmental aspects of the system were to be given precedence over cost considerations. This background paper examines the safety of using RTGs at Burnt Mountain and assesses the viability of using alternative power sources at the station.

There are three principal issues that must be resolved with regard to the Burnt Mountain Seismic Observatory and its power system. First, should the observatory continue to operate; i.e., is the station still necessary given the changed face of world security coming with the end of the Cold War? The Air Force has recently been given the responsibility for monitoring compliance with a worldwide comprehensive test ban treaty in addition to its previous treaty monitoring duties. Fully monitored stations such as the one at Burnt Mountain are important to this new assignment. The Air Force



## 2 | Power Sources for Remote Arctic Applications

considers the data from Burnt Mountain to be critical. Thus, this background paper assumes that the station will remain operational. Second, assuming that the station continues to operate, when should the RTGs be replaced? Should the RTGs remain in place until the end of their useful power production at the station or should they be replaced at an earlier time? The current RTGs could conceivably fully power the observatory until 2009. Several of the units could power their associated equipment until 2018 or later. Third, what power system could be used to eventually replace the RTGs? Leading candidate technologies include: modified RTGs, propane-fueled thermoelectric generators (TEGs), and photovoltaic (PV) systems.

### AIR FORCE FINDINGS

The Air Force, at the request of Senator Murkowski, conducted a study of RTGs and alternative power technologies for the Burnt Mountain station.<sup>1</sup> The study concluded that:

... continued use of the RTGs is clearly the safest, most reliable, and most economical approach to supplying electrical power to the Burnt Mountain Seismic Observatory. . . . [The RTGs] should continue to be operated until the end of their useful power life. The first unit falls below the required power level in 2009. For an added margin of safety it is recommended that combustible materials be cleared annually from the equipment sites.

A logical plan would be to phase out the RTGs as they reach the end of their useful lifetimes. This approach would also provide the opportunity to field test replacement systems without jeopardizing the reliability of the observatory operations. . . . [A]t this time, propane-fueled TEGs appear to be the best candidate for immediate replacement of the RTGs. However, by the end of the projected useful lifetime of the RTGs other, emerging technologies may prove more economical and safe than the TEGs.

The Air Force's preference for TEGs stems from their proven track record in applications with climate conditions and energy requirements similar to those at Burnt Mountain. In addition, TEGs could be deployed in a dispersed configuration similar to that used by the RTGs now.

A PV system was found to be the next most viable option. A major design issue with such a system is how to deliver adequate power during the dark winter months in the Arctic. The Air Force examined PVS with two different power backup systems for the winter--batteries and TEGs. The stand-alone PV/battery system was judged less desirable, because of the expense of the large number of batteries required. The high cost covers not only the initial purchase of the batteries, but also their transport to Burnt Mountain. Several other power technologies were examined for the application, but were considered too costly, too unreliable, or unproven.<sup>2</sup>

---

<sup>1</sup>Wright Laboratory, Aeropropulsion and Power Directorate, Aerospace Power Division, "Power System Assessment for the Burnt Mountain Seismic Observatory," report prepared for the Air Force Technical Applications Center, Patrick Air Force Base, FL, May 1994.

<sup>2</sup>Considered too costly or too unreliable by the Air Force were: fuel cells, aluminum-air batteries, gasoline-powered combustion-engine-driven generators, wind turbine with battery storage, commercial power with a land-line connection. Considered too unproven were: combustion thermionic generators, thermal photovoltaic generators, combustion-driven stirling generators, microwave power beaming, hydrogen thermoelectric converters, and alkali metal thermoelectric converters.

## OTA FINDINGS

OTA, with help from Future Resources Associates, examined the safety and environmental characteristics of RTGs and alternative power technologies under several accident scenarios.<sup>3</sup> The use of RTGs presents risks to people and the environment through the possible release of Sr-90. However, the probability of any accident--with the exception of dedicated vandalism--causing a release of radioactive material to the environment is very low. No natural disaster presents much risk of causing a release of radioactive material to the environment, and most accidents associated with human activities present little risk of contamination. In the event that radioisotope material is released, there would probably be minimal long-range dispersal, so that cleanup activities would be able to remove the bulk of the material in the units. Residual radioisotopes in the environment would remain embedded in a fairly inert ceramic material, with minimal uptake by plants and incorporation into the food chain. It appears reasonable to conclude that continued operation of the RTGs at Burnt Mountain presents minimal risk to the surrounding area and population.

The use of TEG power systems at Burnt Mountain would introduce different risks to the facility. In the event of an accident, TEGs are more likely than RTGs to damage the station's equipment and less likely to harm people and the environment. Propane fuel is flammable and explosive (in certain mixtures with air), and its use would subject the seismic equipment to a variety of risks due to fires and explosions. Accidents could arise in delivering propane fuel to the remote Burnt Mountain site, and in distributing fuel on the ground at the site. Propane acci-

dents during unattended operation of the observatory can be caused either by natural events, like offsite fires and earthquakes, or by vandalism. The TEG power systems would not present any substantial risks to nearby populations, except in the event that a propane fuel accident ignites a fire that spreads offsite--an unlikely occurrence given the cleared area around the seismic facilities,

PV energy systems present minimal risks for the environment during routine operation, maintenance, and transportation. There are, however, potential safety and environmental problems associated with PVs--particularly the batteries--in accident situations. Releases of toxic heavy metals into the environment is a potential problem. Annual maintenance visits are recommended for PV/battery systems, but no annual fuel deliveries are necessary. Of course, if TEGs were used as the winter backup for the PV system, there would be additional risks of the sort mentioned earlier. However, since the fuel requirements would be smaller, the risk would be somewhat lower than for a stand-alone TEG system.

There are many timing variations associated with the implementation of alternative power sources at the Burnt Mountain observatory. Figure 1-1 illustrates several timing possibilities for deploying the three major candidate power systems at the station. The simplest from a logistics viewpoint is continuing to operate the RTGs (Option 1). Without any changes whatsoever, RTGs could fully power the station until 2009--another 15 years. There are also methods for extending the life of the RTGs. In this vein, the Air Force has considered: discontinuing the use of noncrucial communications equipment--specifically the voice frequency responder--at the sta-

---

<sup>3</sup>Future Resources Associates, "Power System Assessment for the Burnt Mountain Seismic Observatory," OTA contractor report, January 1994.

## 4 I Power Sources For Remote Arctic Applications

**FIGURE 1-1: Timeline of Power Options for the Burnt Mountain Seismic Observatory**

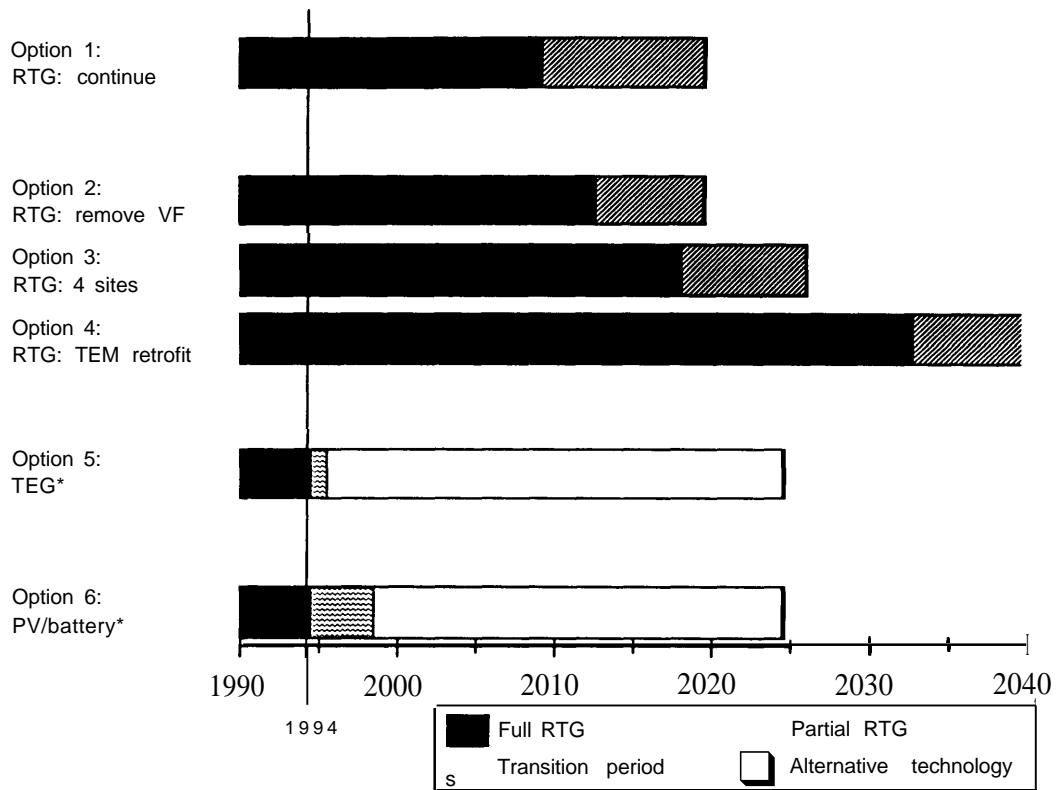

**KEY:**

RTG = radioisotope thermoelectric generators

VF = voice frequency responder

TEM = thermoelectric module

TEG = propane-fueled thermoelectric generators

PV/battery = photovoltaic array with battery backup

\*Earliest implementation of replacement technology. Later deployment is also viable.

The black region ■ indicates the time period in which RTGs fully power the observatory. The patterned region ▨ indicates the time period when RTGs can only partially power the observatory. The patterned region ▩ indicates the transition and/or testing period between RTGs and the replacement power technology. Note that in this period the RTGs are still onsite. The white region □ indicates the period in which replacement technologies fully power the observatory and the RTGs have been removed. The RTGs are removed at the end of the patterned regions.

tion (Option 2); allowing one of the station's five monitoring devices to shut down (Option 3); and refitting the RTGs with improved thermoelectric modules (Option 4).<sup>4</sup> These changes could extend the life of the RTGs by three to 23 years and could be implemented any time up until 2009 with minimal degradation of effectiveness. Propane-fueled TEGs could be implemented very quickly, possibly by next year (Option 5). The RTGs could not be removed as soon, because they would be needed as backup during the startup and associated troubleshooting of the TEG systems. PV/battery systems (Option 6) would require more time to put in place at Burnt Mountain, because more extensive testing and troubleshooting is needed. However, if testing were started in the near future, a reliable PV/battery system could probably be operational in three to four years. Assuming that arrangements could be made for the long-term storage of the RTGs, they could be removed shortly after the PV testing was complete.

### CONCLUSIONS

Continued use of RTGs at Burnt Mountain bears low risk for the safety of maintenance workers and local populations and for the environment. In addition, it minimizes costs and further environmental disruption to the site. The Air Force's recommendations for the clearing of combustible materials from the equipment sites on a yearly basis are sound. Other useful precautions that should be considered are:

- . Installing equipment to protect the sites from lightning strikes.
- . Performing a periodic check of the structural integrity of the RTG units, assuming that useful nondestructive testing can be performed onsite. Such testing would monitor any degradation of materials within the RTGs due to long-term exposure to radiation.

- . Installing intrusion monitors at the station that would alert Air Force personnel at Fort Yukon and authorities in nearby villages to possible problems with vandals or terrorists. This would help reduce the risk of radiation releases caused by dedicated vandalism by allowing quick response to the situation by Air Force personnel and civilian law enforcement authorities.

Looking to the eventual replacement of the RTGs at Burnt Mountain, the interrelated factors of substitute power technologies and replacement timing must both be considered. If the RTGs were required to be removed immediately, the only viable replacement power source would be propane-fueled TEG systems. TEGs are the only replacement technology that could be installed without extensive testing. The deployment of TEGs would introduce the risk of damage to the equipment at the station. In addition, there is the high cost of installing TEGs and of transporting the fuel.

If use of the RTGs could be tolerated for three or four more years or possibly until the end of their useful lives, other power technologies may prove viable replacements. Several years of onsite testing would probably be adequate to prove the suitability of alternative power technologies that do not require ongoing fuel deliveries. At present, PV/battery systems appear to be the most viable nonfuel replacements for the RTGs. PV power generation, which is accomplished without fuel or moving parts, is inherently more reliable than power generation with technologies that use conventional hydrocarbon fuels. PV systems currently provide reliable power for remote, unattended applications in polar Alaska and Antarctica. However, only a survey of the solar and weather conditions at Burnt Mountain and onsite testing of prototype PV designs can establish the viability of a PV power system for the observatory.

---

<sup>4</sup>. Terry A. Schmidt, Technical Operations Division, McClellan Air Force Base, letter to the Air Force Technical Applications Center on the status of Burnt Mountain radioisotope thermoelectric generators, 1992.

## **6 | Power Sources for Remote Arctic Applications**

The process of investigating the suitability of PV systems as an alternative could begin soon, to develop adequate onsite experience to ensure system reliability. The specific system to be tested should be a stand-alone, decentralized PV/battery system. In addition, onsite testing of low-power seismic monitoring and data communication electronics would be helpful. System electronics with decreased power demand would facilitate the use of alternative power systems. They would also extend the life of the RTGs if their continued use at Burnt Mountain were deemed the proper course of action.

---

# Background | 2

The Air Force is responsible for verifying international compliance with nuclear weapons testing treaties. The principal test ban agreements in force are the Limited Test Ban Treaty of 1963, the Threshold Test Ban Treaty of 1974, and the Peaceful Nuclear Explosions Treaty of 1976. To accomplish this mission, the Air Force Technical Applications Center (AFTAC) operates and maintains the U.S. Atomic Energy Detection System, a worldwide system of sensors to detect nuclear explosions underground, underwater, and in the atmosphere and space. The system relies on seismic and hydroacoustic data, satellite information, and collected air and ground debris. AFTAC is headquartered at Patrick Air Force Base (AFB), Florida, and has 14 detachments, six operating locations, and approximately 70 equipment locations. Burnt Mountain is one of seven sites in Alaska, and 19 sites worldwide, that collect seismic data. The system uses multiple monitoring sites and sophisticated signal enhancement (beamforming) data analysis techniques to detect very small seismic sources and to distinguish between ground disturbances caused by nuclear weapons tests and those caused by natural geological phenomena such as earthquakes. AFTAC Detachment 460 (Det-460), located at Eielson AFB (near Fairbanks, Alaska), is responsible for operating the Burnt Mountain observatory and several other seismic monitoring stations in Alaska.

Changes in world security following the Cold War call into question the necessity of the Burnt Mountain Seismic Observatory and other Air Force stations like it. The stations were installed to monitor the Soviet Union during a time when there was no access to Soviet territory. Today, a worldwide network of open seismic stations--including several on the territory of the former Soviet Union--are providing data that vastly supplements the Air Force's capabilities. The role of AFTAC's network of seismic stations is different in this new environment, but it remains important. AFTAC has recently been assigned to improve its capability to meet the more stringent monitoring requirements of the Comprehensive Test Ban Treaty currently being negotiated. This new assignment has increased the value of the data from Burnt Mountain. The Air Force views the observatory as one of an integral handful of recording sites that will comprise the core event detection network of the new treaty monitoring network. These closely monitored sites will be used to cue the open system to which events need to be examined more closely. Furthermore, guaranteed future access to data from seismic stations in the former Soviet Union or near other regions where nuclear testing is likely to

## 8 | Power Sources for Remote Arctic Applications

occur cannot be relied on. In this background paper, the Burnt Mountain Seismic Observatory is assumed to operate for 30 more years.

The option of closing the Burnt Mountain site is complicated by the possible loss of other Det-460 seismic stations (or at least the prospect of greatly increased logistical expenses at other stations). One seismic monitoring station, on the Aleutian Island of Attu, can only be reached by crossing two small bridges that need replacement or extensive repair. Two additional stations are located at Air Force radar stations, which provide power and some logistical support. If the radar facilities were closed for some reason, the seismic equipment would have to be powered independently or shut down. Closing these seismic stations would make the Burnt Mountain site that much more important, while keeping them open would be facilitated by using whatever replacement power system is selected for Burnt Mountain.

### EQUIPMENT AND OPERATIONS

The principal equipment at Burnt Mountain consists of the borehole seismometers to collect the seismic data and a signal multiplexer and a radio to communicate the data offsite for analysis. There are five seismometers clustered within a 1.5 mile radius and linked to a central communications station via surface-laid data cable (figure 2-1). The remote terminals (RTs)--identified as sites U1, U2, U3, U4, and U5--each consist of a borehole, a seismic sensor, and a metal frame shelter for housing the power generators and associated power conditioning equipment (figure 2-2). The remote operating facility (ROF), near site U3, houses the signal multiplexer and the communications equipment. Data from the five sensors are fed to the ROF via data cables, multiplexed into a single data stream, transferred to Fort Yukon, Alaska, via line-of-sight UHF radio, transmitted to Det-460 at Eielson AFB via satellite link, and then sent on to

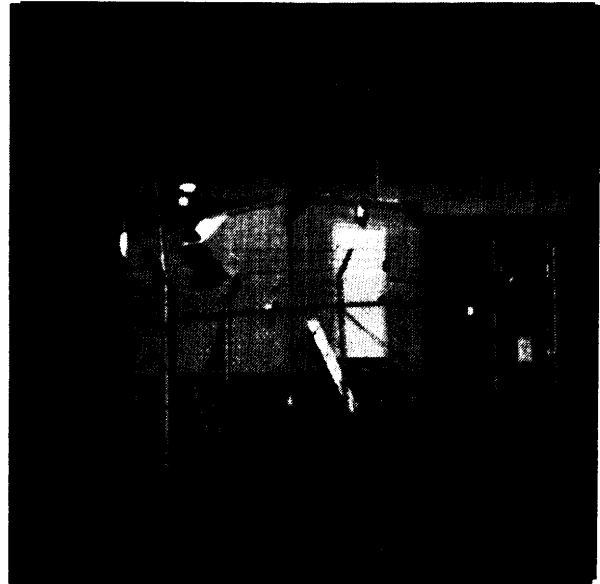

Gerald Epstein

*Shed containing the RTGs powering one of the remote seismometers in the Burnt Mountain observatory.*

AFTAC headquarters and also to McClellan AFB near Sacramento, California. Multiple seismometers are used to increase the sensitivity of the readings. The five data signals are computer processed to diminish noise, allowing clearer characterization of the seismic activity.

Each equipment shed is fenced in and the surrounding area is cleared of trees and other vegetation to a distance of 50 feet. There are two additional shelters located near the ROF. One serves as lodging for maintenance crews and the other houses the station's all-terrain service vehicle.

There are three site visits programmed each year: one scheduled maintenance, one scheduled inspection, and one unscheduled maintenance. However, since 1985--when most of the radioisotope thermoelectric generators (RTGs) were installed--there has been an average of six visits a year for the purposes of maintenance, inspection, and orientation. There has never been a station outage caused by the RTGs since the first one was installed in 1973. There have been sig-

**FIGURE 2-1: Layout of Burnt Mountain Seismic Observatory  
Showing Distances Between Equipment**

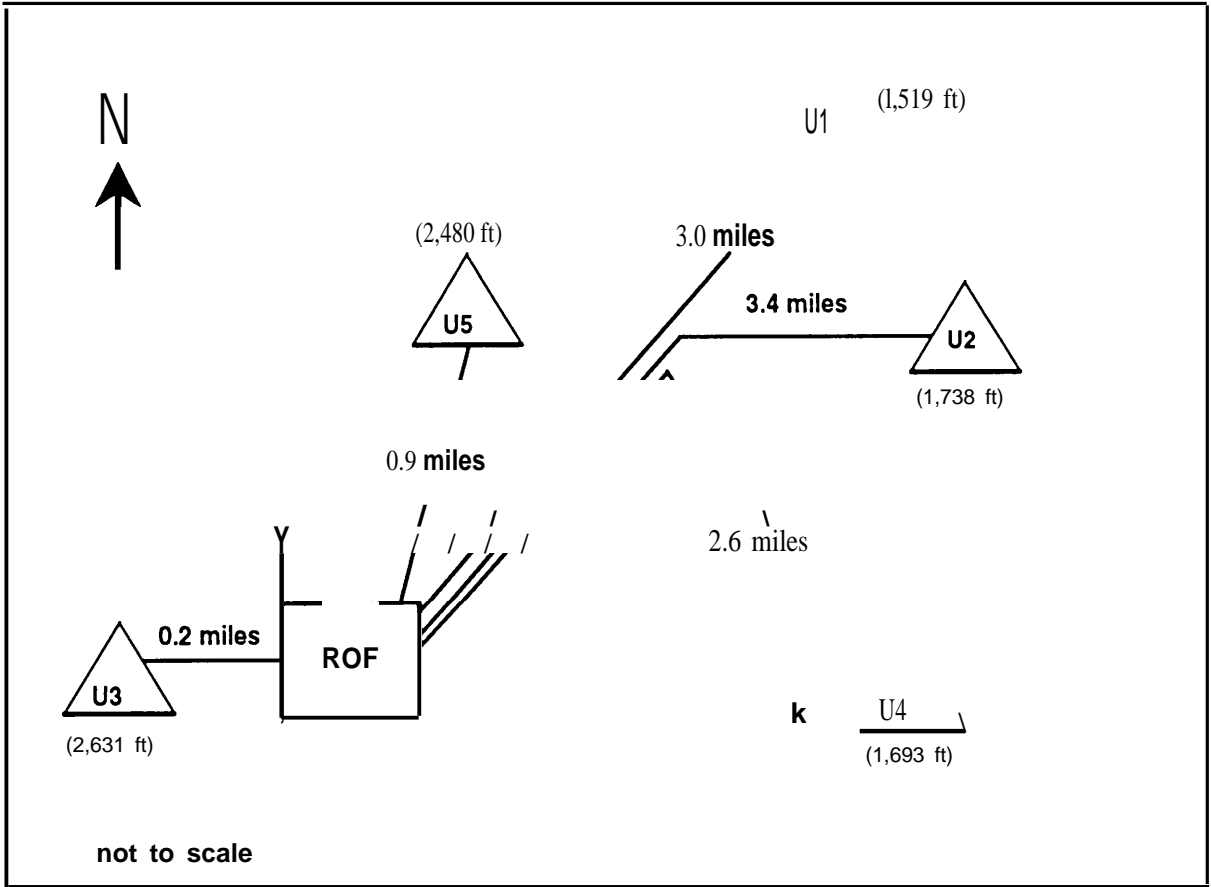

**KEY:** ROF = remote operating facility.  
Numbers in parentheses are elevations given in feet above sea level.

SOURCE: Wright Laboratory, Aeropropulsion and Power Directorate, Aerospace Power Division, "Power System Assessment for the Burnt Mountain Seismic Observatory," report prepared for the Air Force Technical Applications Center, March 1994.



## 10 | Power Sources for Remote Arctic Applications

**FIGURE 2-2: Configuration and Measured Power Requirements of Equipment at Burnt Mountain Seismic Observatory**

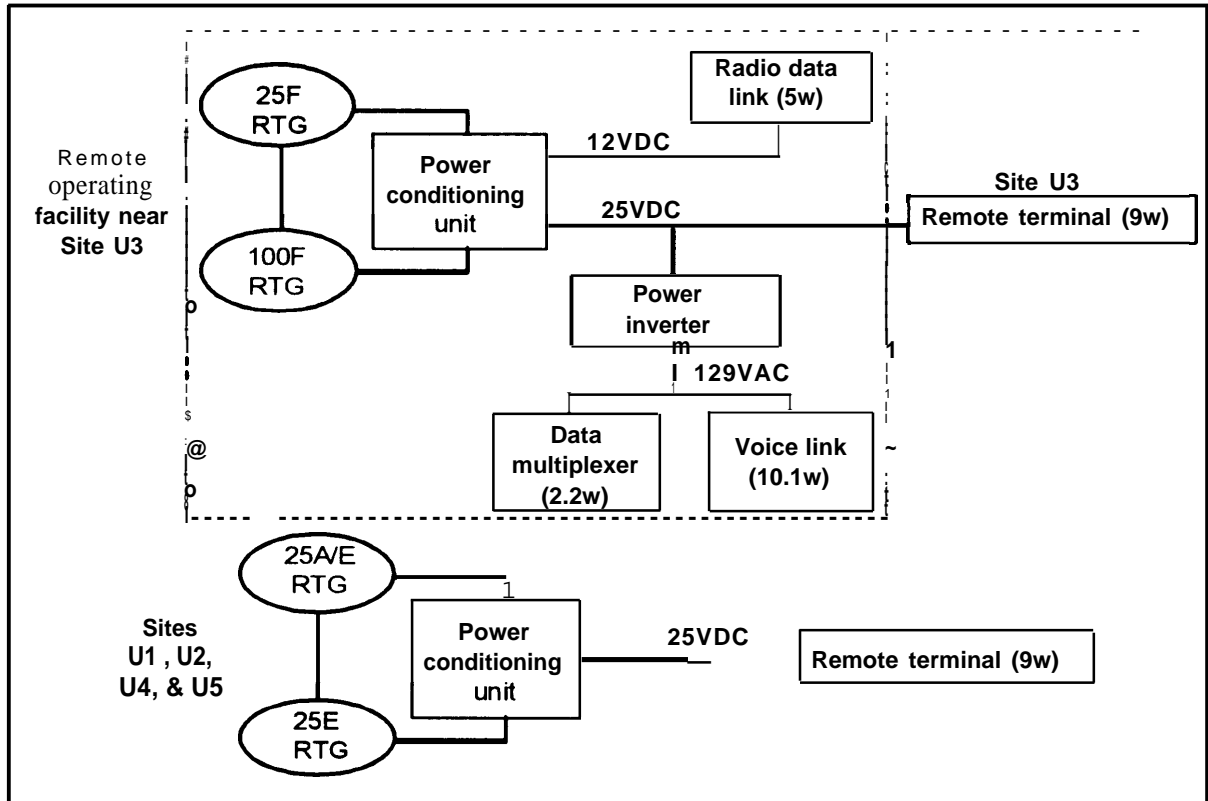

### NOTES:

- 25A/E, 25E, 25F and 100F refer to the RTGs model numbers.
- Remote terminals - Designed in the early 1980's with Transistor-Transistor Logic (TTL) technology.
- Power conditioning units - Designed in 1985 using discrete transistor technology for operation with RTGs.
- Data multiplexer - Line Sharing Unit that multiplexes data from the five sites at Burnt Mountain. Designed using Small Scale Integration-complementary metal-oxide silicon (CMOS), analog, TTL technology.
- Inverter - Converts direct current (DC) to alternating current (AC) to provide power for the data multiplexer. Technology is discrete and TTL.
- Voice link - Voice frequency responder for testing the communications circuit. Since an inverter is used to power the data multiplexer, AC power is available to accommodate and AC powered responder.
- Radio data link - Commutronics radio with Small-Scale Integration technology, analog and discrete.

SOURCE: Wright Laboratory, Aeropropulsion and Power Directorate, Aerospace Power Division, "Power System Assessment for the Burnt Mountain Seismic Observatory," draft report prepared for the Air Force Technical Applications Center, Patrick Air Force Base, FL, Oct. 29, 1993,

nal outages associated with problems with the power conditioning electronics, radios, seismic instruments, and data cable.<sup>1</sup>

## RADIOISOTOPE THERMOELECTRIC GENERATORS

The seismometers, multiplexer, and radio equipment discussed in the previous section require low, but very reliable power. These devices are currently powered by 10 RTGs. There are two Sentinel 25 RTGs each at sites U1, U2, U4, and U5, and one Sentinel 25 and one Sentinel 100 RTG at the ROF near site U3. Currently, the Sentinel model 25s generate about 9 to 20 watts and the model 100 generates about 54 watts. The larger RTG is used at site U3 to power the communications equipment as well as the site's monitoring device. The RTGs produce low voltage direct current (DC) output; power conditioning and conversion equipment is used to convert the power to the necessary voltages and forms (DC or alternating current--AC). Each of the five RTs uses electricity in the form of 25V DC, The ROF uses electricity in two forms, 129V AC and 12V DC. There currently is no power distribution capability between the five RT sites at Burnt Mountain.

RTG technology was developed under the Atomic Energy Commission's "Beneficial Uses of Radioactive Material" program begun in 1959, RTGs are used in remote applications such as Arctic stations and space vehicles, where small amounts of highly reliable, low-maintenance power are required. The first RTG was installed at Burnt Mountain in 1973 and nine additional ones were installed in 1985. The unit installed in 1973 was purchased directly

from Teledyne. Some of the units installed in 1985 came from the Federal Aviation Administration; others were Navy surplus. They have never failed to produce power.

The RTGs at, Burnt Mountain differ slightly from one another in terms of their date of fueling and power capacity. Thus their useful life at the station also varies. Table 2-1 shows when the RTGs will cease to provide enough power for their associated equipment. The RTGs, as currently configured, could fully power the observatory until March 2009. Several of the units could be used longer, but all would need to be replaced or modified by June 2019 at the latest. These are the earliest dates that the generators would have to be replaced. Advances in the system electronics that reduce power requirements should outpace RTG power degradation, The Air Force has considered several options for extending the life of the RTGs.<sup>2</sup>

- . Discontinuing the use of the voice link used to test the communications circuit. This would extend the life of the RTGs at site U3 by 10 years, making the RTGs at site US the first to need replacement (in 2012).
- . Allowing the power to cut off at site US. When coupled with the previous option, this would extend the life of the RTGs at the station until 2018.
- . Installing improved thermoelectric modules (TEMs), the internal RTG components that convert the heat into power.<sup>3</sup> The current TEMs have an efficiency of about 5 percent; improved ones would be about 15 percent efficient, effectively tripling the power output of the RTGs,<sup>4</sup> With improved TEMs, the RTGs could power the observatory equipment until

<sup>1</sup>Lt. Col. Terry Fout, letter to Alaska Porcupine Caribou Commission, Nov. 3, 1992.

<sup>2</sup>Col. Terry A. Schmidt, Technical Operations Division, McClellan AFB, letter to the Air Force Technical Applications Center on the status of Burnt Mountain radioisotope thermoelectric generators.

<sup>3</sup>Refitting the RTGs with new TEMS would require an additional Certificate of Compliance from the Nuclear Regulatory Commission, See section on Licenses and Emergency Plans in chapter 5 of this report.

<sup>4</sup>Improvements in thermoelectric conversion efficiency depend on the timing of the installation. Were new modules fabricated today, their efficiency would be on the order of 10 percent. If they were fabricated in 20 years or so, 15 percent efficiency may be possible given the potential advances in thermoelectric material technology.

**TABLE 2-1: RTG Models, Power Demand, and  
Estimated Replacement Dates**

<u>Site number</u>	<u>RTG serial number</u>	<u>RTG model number</u>	<u>Present power output (watts)<sup>a</sup></u>	<u>Site power demand (watts)<sup>b</sup></u>	<u>Estimated replacement dates</u>
U1	8	Sentinel 25E	10.4	9.0	June 2018
	17	Sentinel 25E	14.8		
U2	9	Sentinel 25E	9.8	9.2	January 2018
	20	Sentinel 25E	14.4		
U3	1	Sentinel 100F	42.3	26.2	March 2009
	14	Sentinel 25F	10.4		
U4	10	Sentinel 25E	9.5	9.0	June 2019
	18	Sentinel 25E	15.1		
U5	4	Sentinel 25A	6.7	9.0	August 2012
	19	Sentinel 25E	14.6		

a power losses of 20 to percent due to heat losses have been factored in.

b Measured loads of the equipment as recorded by the Air Force Technical Applications Center/Technical Operations Division engineers during a June 1992 site visit.

**SOURCE:** Office of Technology Assessment based on data from Wright Laboratory, Aeropropulsion and Power Directorate, Aerospace Power Division, 'Power System Assessment for the Burnt Mountain Seismic Observatory,' report prepared for the Air Force Technical Applications Center, March, 1994.

2032 to 2047 depending on the particular site. The TEMs do not have to be installed immediately to realize these gains. Putting them in anytime before the RTGs otherwise become too weak to power their equipment is sufficient.

There are other power management techniques that could extend the operating life of the RTGs. For example, swapping generators number 14 and number 17 would extend the lifetime of the Burnt Mountain RTGs by 2 1/2A years (to September 2011). Also, installing future generations of seismic and power conditioning electronics, which are likely to require less power, would

extend the useful life of the RTGs. With these kinds of power management methods and likely improvements in system electronics, it is entirely possible that RTGs could power the Burnt Mountain station well into the second if not third decade of the next century.<sup>5</sup>

### **STRONTIUM-90 FUEL**

Each of the RTGs at Burnt Mountain contains between 1.2 and 3.9 pounds of Strontium-90 (Sr-90) fuel. Sr-90 produces the heat needed in the RTGs via radioactive decay, not through fission or fusion. It is manufactured as a byproduct of spent nuclear fuel reprocessing. <sup>6</sup> Sr-90 has

<sup>5</sup>John F. Vogt, Sentinel Program Manager, Teledyne Brown Engineering-Energy Systems, personal communication, Mar. 18, 1994.

a half-life of 28 years. This makes it suitable for long-term power uses. RTGs do not require constant refueling.

In the RTGs, the Sr-90 fuel is in the form of hockey puck-sized disks of strontium titanate ( $\text{SrTiO}_3$  or  $\text{SrTiO}_4$ ), a solid ceramic material. This material was selected in large part for its strength, fire-resistance, and low water-volubility.

Sr-90 is the main source of environmental risk associated with the RTGs at Burnt Mountain. It is not an explosive material, but is hazardous if dispersed by other means. Sr-90 and its only radioactive decay product, Yttrium-90 (Y-90), are both beta emitters. Beta particles from Sr-90 travel about 10 inches in air and those of Y-90 travel about 100 inches in air. The particles travel shorter distances in liquids and solids. Close contact with the radioisotope through ingestion or inhalation is necessary to deliver a long-term beta dose of radiation to the body. Beta particles, such as those from decay of Sr-90, also create x-rays (Bremsstrahlung radiation) as they are slowed down in the surrounding fuel and shielding material. X-rays are penetrating radiation that can deliver a radiation dose from outside the body.

Sr-90 follows calcium metabolically, and if ingested or inhaled in a biologically available form (i.e., as a substance that is soluble in the bloodstream or other fluids of a living organism) accumulates in the bones. From there it continues to deliver radiation to associated tissues over its entire radioactive life. This has been found to induce bone cancer and in some cases leukemia.<sup>6</sup> If Sr-90 is ingested or inhaled in a relatively nonbiologically available form--such as strontium titanate--the material passes from the body naturally, delivering primarily a short-term dose of radiation.

## LOCATION AND CLIMATE

Burnt Mountain is located at  $67^{\circ}25'$  north latitude,  $144^{\circ}36'$  west longitude, approximately 62 miles north of the Arctic Circle (figure 2-3). It is a remote area about 50 miles from the closest villages (Venetie, Arctic Village, and Chalkyitsik) and 56 miles from the nearest Air Force facility (Fort Yukon Air Force Station),

The site was chosen for a seismic observatory because of its geologic structure and long distance from human sources of noise. Its hard-rock surface surrounded with soft soil yields very clear seismic signals with minimum noise.

The Burnt Mountain observatory lies in the foothills of the Brooks Range, so the terrain in the immediate vicinity is mountainous. There is a 1,100-foot difference in elevation between the highest and lowest of the sensor sites. The land is tundra that varies from barren rocky ground to areas of considerable cover, mostly white and black spruce and some aspen, birch, and wil-



Gerard Epstein

*View of the ROF site at Burnt Mountain. The RTGs powering this site are located inside the structure within the fence. Several kilometers in the distance is a small clearing containing one of the remote seismographs.*

<sup>6</sup>Sr-90 is **not** formed in nuclear weapons explosions and is a component of radioactive fallout.

<sup>7</sup>John H. Harley, "Radioactive Fallout," *McGraw-Hill Encyclopedia on Science and Technology*, 7th ed. (New York, NY: McGraw-Hill, 1992).

## 14 | Power Sources for Remote Arctic Applications

**FIGURE 2-3: Map of Alaska Showing the Location of the Burnt Mountain Seismic Observatory and Nearby Communities**



SOURCE: Office of Technology Assessment, 1994.

lows. Vegetation has been cleared to a distance of 50 feet from each of the sensor sites. Discontinuous permafrost exists in the area. There is also wildlife in the area, including barren-ground caribou, grizzly and black bears, moose, and a variety of fur bearers and ptarmigan.<sup>8</sup>

The climatic conditions at Burnt Mountain are not known precisely; the nearest weather observatory is at Fort Yukon. Climatic conditions for Fort Yukon are summarized in table 2-2. Average daily temperatures range from -22°F in the

winter to 63°F in the summer, and extremes of -71° to 100°F have been recorded. Humidity is nil to low year round. Precipitation is moderate. Wind speeds are low year round. Monthly average wind speeds range from 3 to 7 knots. Gusts as high as 35 knots were recorded during the 1980s.

The extreme northern location of the site limits daylight that might be useful for solar power. Average daily daylight ranges from 21 to 24 hours during the summer and 2 to 3 hours

<sup>8</sup> Corp. of Engineers, Alaska District, *Environmental Impact Assessment*, AFTAC Project F/1081 (Anchorage, AK: May 1972).

TABLE 2-2: Climate Conditions at Fort Yukon

	Temperature		Other	
	Low ("F)	High ("F)		
Winter (average)	-22	-2	Wind (average)	less than 5 knots (5.8 mph)
Spring (average)	29	54	Wind (gusts)	35 knots (40 mph)
Summer (average)	42	63	Precipitation	17 inches annually
Fall (average)	-9	6	Humidity	low
Extremes	-71	100		

SOURCES: Wright Laboratory, Aeropropulsion and Power Directorate, Aerospace Power Division, "Power System Assessment for the Burnt Mountain Seismic Observatory," draft report prepared for the Air Force Technical Applications Center, Oct. 29, 1993; and Letter from Senators Stevens and Murkowski to the Office of Technology Assessment, Oct. 27, 1993.

during the winter. Certain days in the winter, though, receive no sunlight at all. The average daily insolation, a measure of the intensity of sunlight, varies between a low of 0.1 MJ/m<sup>2</sup> in December to a high of 18.5 MJ/m<sup>2</sup> in May.<sup>9</sup>

There are no roads in the area. All personnel and materials are flown in from Fort Yukon via helicopter. Fort Yukon is the principal staging area for Burnt Mountain, but is only marginally more accessible. Personnel and incidental materials are flown in and bulk supplies are delivered via barge. Bulk transport from Fairbanks is by road to Nenana (50 miles southwest of Fair-

banks) and then by barge on the Yukon River to Fort Yukon. There are three barge trips per year--June, July, and September.

The Alaska District Corps of Engineers conducted an Environmental Impact Assessment for siting the observatory at Burnt Mountain and two other locations in 1972. The assessment focused almost exclusively on the environmental impact of the construction of the facilities, not on their operation. Impacts discussed clearing vegetation and soil erosion as a result of vegetation removal and road access.<sup>10</sup>

<sup>9</sup>Solar Energy Research Institute (now the National Renewable Energy Laboratory), *Solar Radiation Energy Resource Atlas of the United States*, SERUSP-642-1037 (Golden, CO: October 1981). Data is for Big Delta, AK, with panels tilted at 64° (latitude) from horizontal.

<sup>10</sup>Corps of Engineers, op. cit., footnote 8.

# Evaluation Criteria 3

There are three principal performance criteria that the power source used for the Burnt Mountain Observatory must meet: high reliability, safe and environmentally benign operation, and reasonable life-cycle cost. An overview of these evaluation criteria is presented in this chapter, and the discussion of radioisotope thermoelectric generators (RTGs), propane-fueled thermoelectric generators (TEGs), and photovoltaic (PV) systems and their ability to meet these requirements appears in subsequent chapters. The reliability and cost characteristics of the power systems are assessed in chapter 4; the safety and environmental characteristics are examined in chapter 5.

## RELIABILITY

The importance of the Burnt Mountain station's mission and the difficult access to the site require that the monitoring and communications equipment and their power sources be very reliable. It was this need for high reliability that led to the use of RTGs as the power source for the site in the first place. The reliability of RTGs derives from their lack of moving parts and their ability to provide continuous power over a very long period without refueling. The RTGs at Burnt Mountain have all been in service at the station for over eight years and could conceivably power the seismic sensing equipment for another 15 to 25 years (see table 2-1). In addition, RTGs require little maintenance.

Though a highly reliable power system is certainly very important and very desirable, a certain risk of power outages can be tolerated. The station collects and transmits signals from five seismic devices. Loss of one of the five signals should not deteriorate the data signal a great deal, and probably can be endured for a short time. As mentioned earlier, the Air Force has considered letting one of the signals cut off permanently as a means of extending the life of the station.<sup>1</sup> This indicates some

---

<sup>1</sup>Col. Terry A. Schmidt, Technical operations Division, McClellan Air Force Base, letter to the Air Force Technical Applications Center on the status of Burnt Mountain radioisotope thermoelectric generators, 1992.

## 18 I Power Sources for Remote Arctic Applications

willingness to accept a slightly degraded signal caused by a power problem, but new Comprehensive Test Ban Treaty mission requirements (described in chapter 2) may force a revision of the data requirements toward higher reliability. Note, however, that the system powering the communications equipment must meet a higher standard of reliability than the other power systems at the station. An outage at the communications link means the loss of all five of the signals, not just one.

When considering alternative power technologies, the need for high reliability puts a high premium on proven technologies. The field experience of technologies in Arctic conditions is of great importance in establishing their reliability.

### SAFETY AND ENVIRONMENT

The safety and environmental characteristics of the RTGs and alternative power systems for the Burnt Mountain Seismic Observatory are of paramount importance. They were the major impetus for this study. Risks to the local population and to Air Force personnel that maintain the station are both of concern. The principal safety and environmental risks of the power systems under consideration stem from:

- . exposure to radioactive material (Strontium-90) from RTGs,
- . fires and/or explosions connected with propane from TEGs, and
- . exposure to toxic fumes and heavy metals from the batteries in PV systems.

Each of the power systems would no doubt be designed to keep the risks associated with these events low. However, the safety and environmental risks would not be eliminated; small risks would remain. The level of risk that can be attained is primarily a question of engineering and economics. The level of risk that can be tolerated is determined socially and politically.

### COST

One of the most important determinants of cost is the configuration of the power sources. In a distributed configuration, each remote terminal (RT) has its own power source. In a central configuration, there is one main power source and the power is transmitted to the RTs via cable. Because of power losses in the transmission stage, the generator in a centralized system must be at least 50 percent larger than the sum of those in a distributed system.

The present energy system at Burnt Mountain uses a distributed configuration, with two generators located at each of the five monitoring/communications sites of the station. A centralized power system for the observatory, presumably located near the remote operating facility (ROF), would require a network to distribute power to the five RT sites. Transmission cables could be strung along the rights-of-way already established for the data cables, either surface laid or buried. The Air Force study recommends that if a centralized system were implemented, the power be transmitted at 120V direct current (DC) to minimize resistive losses. Even so, there would be significant losses associated with stepping the voltage up to 120V and then stepping it back down after transmission. The voltage conversion at each end is on the order of 75 percent efficient. The Air Force is investigating more efficient conversion technologies for this application.

The principal constraints on the operation of power sources are the site's climate and remoteness and its lack of sunlight in the winter. The remoteness and the inclement weather make maintenance of the site costly. There is a premium placed on keeping site visits, especially those with large cargo (e.g., fuel or batteries), to a minimum. This is not only for cost reasons but also for safety reasons. The difficulty of transport also makes extensive construction of power system apparatus at the site very costly.



# Power Source Equipment: Cost and Reliability | 4

## **RADIOISOTOPE THERMOELECTRIC GENERATORS**

Radioisotope thermoelectric generators (RTGs) are a type of nuclear battery that uses the Seebeck thermoelectric effect to generate electric power from the heat of decay of a radioactive material. The Seebeck effect generates a small electric potential in a thermocouple that spans a temperature gradient. In an RTG, many thermocouples--made of semiconductors--traverse the distance from the hot zone near the nuclear center to the device's cool outer surface. Decay of radioactive material (strontium-90--Sr-90--in the RTGs at Burnt Mountain) provides the heat. The thermocouples are connected together as a thermopile to boost the electrical output to useful magnitude. Because radioactive decay occurs as an intrinsic property of radioisotopes, the fuel charge in an RTG can be fixed in place and last many years. RTGs are attractive power systems for remote applications because they have no moving parts, the fuel supply is integral to the system, and the units are sealed, operate passively, and require very little maintenance. This is the basis of their high reliability. The level of power generated depends on the amount of radioactive material the device was fueled with, the length of time since the fueling, and how well the heat flow is focused across the thermoelectric conversion module.

RTGs were developed as part of the effort begun in the late 1950s to find peaceful uses for nuclear materials. The first unit was for a weather station. The Sr-90 used in the Sentinel models at Burnt Mountain is a byproduct of weapons manufacture at Hanford, Washington. It was processed into strontium titanate at Oak Ridge, Tennessee. Teledyne Isotopes Inc., Nuclear Systems (now Teledyne Isotopes Inc., Energy Systems Division trading as Teledyne Brown Engineering-Energy Systems) produced the Sentinel series.

The radioisotope fuel in the RTGs at Burnt Mountain is surrounded by shielding and insulating materials. A schematic cross section of a typical RTG is shown in figure 4-1. The Sr-90 fuel is fabricated as strontium titanate:  $\text{SrTiO}_3$  in the Sentinel 25 models and as  $\text{Sr}_2\text{TiO}_4$  in the Sentinel 100F model. The hockey puck-size material is encased in fuel cladding consisting of a stainless steel liner and a superalloy (Hastelloy C) fuel capsule. This fuel capsule is surrounded by a radiation shield fabricated from tungsten. This in turn is enclosed in thermal insulation to direct the heat upward to the thermocouples. Lastly, there is the exterior housing of the unit. Seven of the RTGs at Burnt

Gerald Epstein

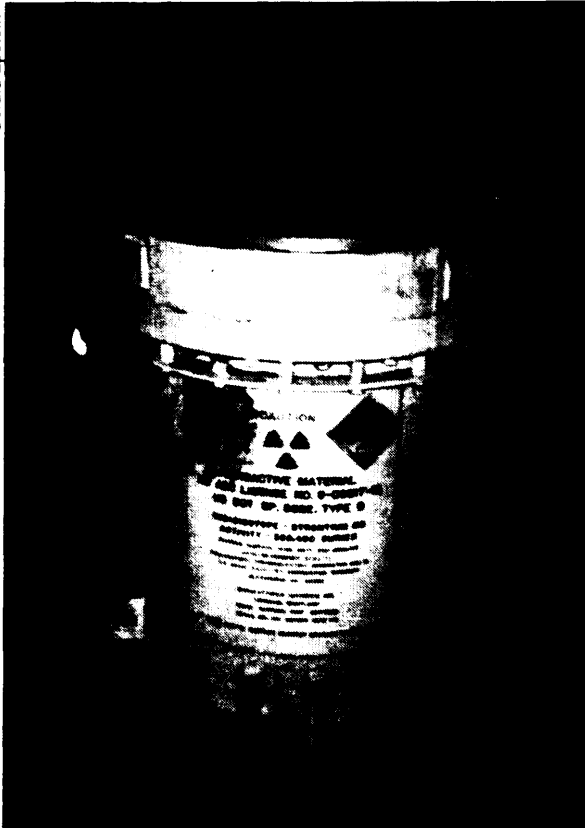

One of the RTGs powering the ROF site at Burnt Mountain, where data are collected from remote seismographs and relayed by radio to Ft. Yukon, some 100 km to the south.

Mountain are housed in steel, two in aluminum, and one in cast iron.

The fuel capsules of RTGs have passed stringent heat, thermal shock, impact, and projectile striking tests without developing any detectable leaks of the radioisotope material. The tungsten radiation shield and the housing together are designed to reduce radiation levels to a maximum of 10 millirem per hour at a distance of 1 meter from the RTG surface. As points of reference, a typical chest x-ray is about 45 millirem, and the average annual whole body dose to a person in

the United States from natural and manmade sources is about 360 millirems.<sup>1</sup> The RTGs as complete units have not been tested. Instead, engineering analyses were conducted to demonstrate that the RTG designs met the applicable Nuclear Regulatory Commission standards for transportation packaging.

Nine of the RTGs at Burnt Mountain produce continuous power of 9 to 20 watts. The one larger unit produces continuous power of **53 watts.** The smaller units contain approximately 1.2 pounds of Sr-90 and the larger one contains about 3.9 pounds. Each RTG weighs approximately 1 to 2 tons. The units are housed in wooden utility sheds. There are actually four models of RTGs at Burnt Mountain; from smallest to largest (in terms of amount of nuclear material) they are: one Sentinel 25A at 50,000 curies (Ci); seven Sentinel 25Es at 56,000 to 61,000 Ci; one Sentinel 25F at 60,000 Ci; and one Sentinel 100F at 189,000 Ci. These quantities represent the estimated activities in April 1994. Other characteristics of the Sentinel RTGs are shown in table 4-1.

Since RTGs are already in place, the cost of their continued operation is far lower than any possible alternative that would have to be constructed and installed there. However, modifications to the generators and/or the electronics systems would be needed to enable the RTGs to provide enough power over the projected life of Burnt Mountain station.

### PROPANE-FUELED THERMO-ELECTRIC GENERATORS

Propane-fueled thermoelectric generators (TEGs) generate electricity on the same principle as RTGs, except that propane or some other hydrocarbon rather than a radioisotope provides the heat. However, unlike RTGs, which can provide

<sup>1</sup>Wright Laboratory, Aeropropulsion and Power Directorate, Aerospace Power Division, "Power System Assessment for the Burnt Mountain Seismic Observatory," report prepared for the Air Force Technical Applications Center, Patrick Air Force Base, FL, May 1994; and National Council on Radiation Protection and Measurements, *Ionizing Radiation Exposures of the Population of the United States*, NCRP report 93 (Bethesda, MD: 1987).

**FIGURE 4-1: Schematic of a Typical RTG Used for Terrestrial Applications**

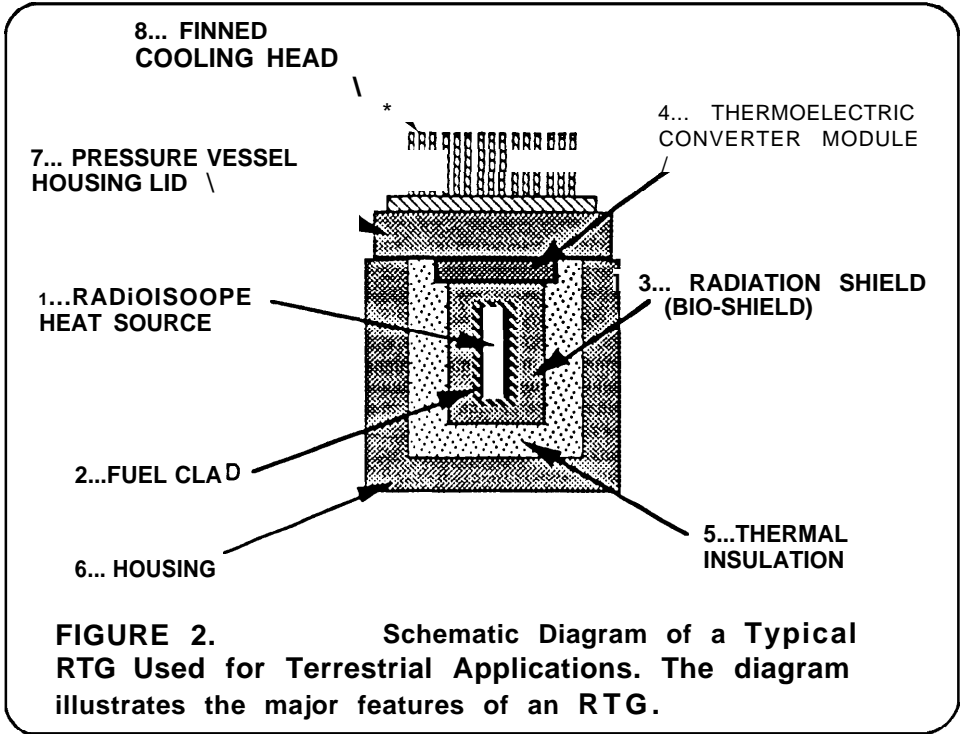

**SOURCE:** Wright Laboratory, Aeropropulsion and Power Directorate, Aerospace Power Division, "Power system Assessment for the Burnt Mountain Seismic Observatory," draft report prepared for the Air Force Technical Applications Center, Patrick Air Force Base, FL, Oct. 29, 1993.

30 years or more on a single fueling, TEGs require periodic refueling. The Air Force estimates that using TEGs in a centralized configuration at Burnt Mountain would consume 6,300 pounds of propane per year.<sup>2</sup> In a distributed configuration, TEGs would consume 5,000 pounds of propane annually. This fuel would have to be stored in large tanks and flown in probably twice a year. The storage tanks would most likely be buried, and the containment would need to be designed to accommodate shifts in the permafrost. In addition, there would need to be some mechanical linkages to control the flow of

propane from the tanks to the TEGs and to prevent problems during periods of extreme cold weather.

TEGs are available in essentially the same power and voltage output ranges as the existing RTGs, and therefore could be directly substituted for the RTGs in the existing shelters and distributed configuration. Alternative)) TEGs could be installed in a centralized mode, in order to simplify fuel handling and storage operations.

It is expected that the propane would be transported in bundled 100-pound capacity cylinders via helicopter. Depending on the ac-

<sup>2</sup>Wright Laboratory, op. cit., footnote 1.

## 22 | Power Sources for Remote Arctic Applications

TABLE 4-1: Characteristics of the RTGs at Burnt Mountain

	Sentinel 25A	Sentinel 25E	Sentinel 25F	Sentinel 100F
Activity of initial charge (curies)	94,000	105,000-109,000	108,000	329,000
Date of initial charge	1968	1969-71	1970	1972
Activity in April 1994 (curies)	50,000	56,000-61,000	60,000	189,000
Exposure rate at housing surface (millirem/M)	55	65	75	125
Voltage (V)	3.3	3.5	3.5	9
Housing material	Cast iron	Steel	Aluminum	Aluminum
Weight (lbs)	3,000	4,170	1,400	2,720
Dimensions, height x diameter (inches)	35x26	42x26	36x20	46x28
Housing pressure rating (PSI)	500	10,000	500	500
Design applications	Tailored to land and shallow water (300 meter depth) applications	Tailored to deep sea (6,700 meter depth) applications, or land applications with cooling head	Tailored to land and shallow water (300 meter depth) applications	Tailored to land and shallow water (300 meter depth) applications

SOURCE: Product brochures from Teledyne Energy Systems (now Teledyne Brown Engineering-Energy Systems), 1986

tual power configuration and the lift capacity of the helicopters used, four to five helicopter trips would be needed per year. The handling and transport of this much propane raises safety questions that are discussed in the following chapter.

TEGs are inherently less reliable than the existing RTGs because of the need for a more elaborate fuel delivery system, whereas the heat source for RTGs is dependent on radioactive decay and is therefore completely passive and immobile. Nevertheless, TEGs are designed for remote operation, including in severe climates, and their performance and reliability have been demonstrated.<sup>3</sup>

The Air Force report recommends deploying TEGs in a distributed configuration in order to enhance overall system reliability, take maximum advantage of existing equipment and facilities, minimize fuel use, and avoid the expense and environmental disruption of installing transmission cables that would be required for a centralized configuration.<sup>4</sup> However, the study does not appear to give adequate consideration to the increased risks and environmental impacts of the extra fuel distribution operations that will be required to service the TEGs in a distributed configuration. The distributed configuration also would have greater environmental impact due to the need for fuel tank installation at five different sites, instead of just one.

The Air Force report also fails to give adequate consideration to the issue of power supply reliability regarding TEGs. The report cites data on the catastrophic failure rate for the machines, but does not develop any data to indicate their reliability with regard to the far more probable

noncatastrophic failure modes, which include problems of flame stability, fuel delivery, and ignition.

## PHOTOVOLTAICS

Solar photovoltaic (PV) panels could be used to power the Burnt Mountain equipment. PV generators share some of the most desirable characteristics of the existing RTGs: no moving parts, no need for fuel deliveries, passive operation, and minimal maintenance that can be performed in conjunction with regular service visits to the site for general maintenance procedures. PV systems present minimal health and environmental risks under normal operating conditions. There are, however, risks associated with PV systems in fires or transportation accidents. Possible releases of corrosive or toxic fumes and/or toxic metals in such events could create health and environmental problems. Annual maintenance visits are recommended for PV power and battery systems, but no annual fuel deliveries are necessary.

PV generators also produce a form of power that is very similar to that produced by RTGs with respect to alternating/direct current (AC/DC) characteristics, voltage, and wattage, and PV systems are ideally suited for distributed operating configurations. Indeed, the majority of PV installations in current operation are remote power applications, many in severe environments.<sup>5</sup> PV systems have been proven as reliable power sources for remote, unattended, low-power applications in sites all over the world, including many sites in polar regions (table 4-2).

The most difficult aspect of designing a PV system for use at the Burnt Mountain Seismic

---

<sup>3</sup>J.H.Doolittle, *Development of an Automatic Geophysical Observatory for Use in Antarctica* (Palo Alto, CA: Lockheed Missiles and Space Co., Inc., Research and Development Division, May 1986).

<sup>4</sup>WrightLaboratory, op. cit., footnote 1.

<sup>5</sup>The Navy has an installation using RTGs at Fairway Reek, west of Wales, Alaska. Stan Read, Environmental Engineering Assistant for Rural Health, Alaska Department of Environmental Conservation, Fairbanks, personal communication, Apr. 18, 1994.

## 24 | Power Sources for Remote Arctic Applications

**TABLE 4-2: Examples of Photovoltaic Power Systems Used in Cold Regions**

Site	Description
Antarctica	Black Island uplink satellite power system, a hybrid that consists of three HR3 wind turbines, 8 kW photovoltaic array, three on-demand 1.2 kW closed cycle vapor turbines.
Antarctica	Energy system for the National Science Foundation portable Sea Ice Laboratory, consisting of a photovoltaic array and heated with passive solar collectors.
Alaska: 8 sites	Hybrid power systems that consist of 720 peak watt photovoltaic arrays, TEGs, and batteries for an Air Force installation.
Canada: Labrador, Newfoundland 2 sites	Solar-powered Obstruction Lighting Systems (SOLS™) to illuminate power transmission lines.

**SOURCE:** Compiled by Future Resources Associates, Inc. from information provided by Northern Power Systems.

Observatory is the extreme northerly location of the site. For approximately a three-month period, November through January, the site receives very little solar resource (insolation). Figure 4-2 shows the solar resource deficit during the winter months for a possible PV array at Burnt Mountain. The observatory must function during this prolonged dark period, when the PV system provides almost no electrical power.

Two approaches are available for powering the observatory during the three-month dark period using a PV power system: 1) a PV stand-alone system using a battery storage system large enough to allow operations throughout the dark period and a PV array large enough to perform long-term charging of the batteries during the summer, and 2) a hybrid system combining PV power in the summer with an alternative, supplemental source of power during the dark period.

A PV power system for the Burnt Mountain Seismic Observatory could be built in either a central or a distributed configuration. In the cen-

tral configuration the PV panels and batteries would all be installed at a single site, and a power distribution system would have to be installed at the site to provide power to each of the five remote terminal (RT) sites, and to the remote operating facility (ROF). In the distributed configuration, five different PV generation installations would be developed near each of the five RT sites, and no electricity distribution system would be required. The distributed configuration is equivalent to the one used with the existing RTG power system.

The Air Force assessment of alternative power technologies for Burnt Mountain suggested that, if a PV system were deployed at the observatory, it should be designed using a centralized configuration, sited near the ROF site. The report recommends a centralized configuration over a distributed configuration because of possible solar access problems at some of the RT sites. In fact, however, PV systems are ideally suited for distributed configurations, and could easily be integrated into the existing system. The centralized configuration greatly in-

**FIGURE 4-2: Solar Balance for a Hypothetical PV Array in an Arctic Location**

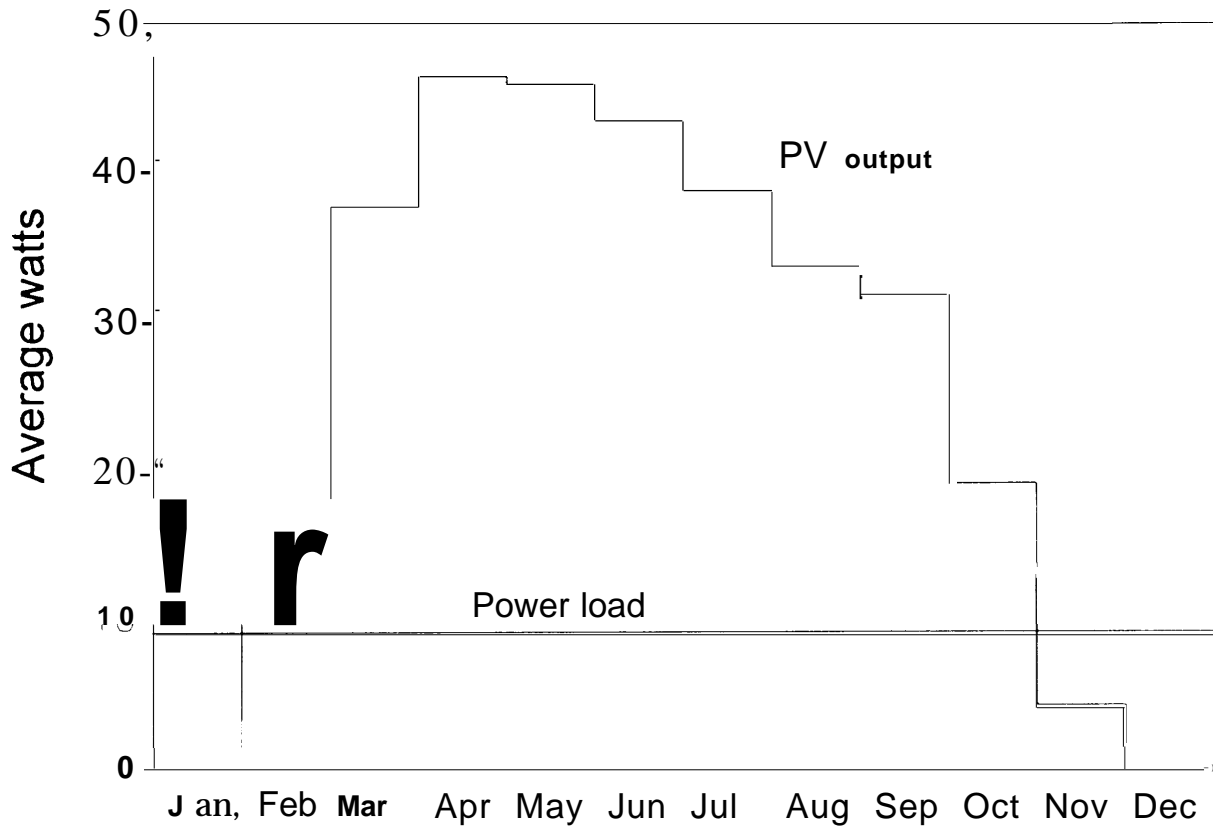

Based on insolation data for Beffles, AK (66°55'N, 151°31'W). The stepped line is the power output averaged over the given month for a PV array consisting of two serial and two parallel PC-4 modules. The straight horizontal line is the power demand of one of the remote terminal sites at Burnt Mountain. The figure shows that there is power surplus in nine months and a deficit in three months (November, December, and January).

SOURCE Siemens Solar

creases the total system cost because of the need for more PV panels and battery capacity, as well as for the installation of a power distribution system.

OTA's contractor, Future Resources Associates, Inc. contacted the three major PV system packagers in the United States: Integrated Power Corporation, Photocomm, Inc., and Northern Power Systems. All three recommended that a distributed configuration be used for a PV power system installation at Burnt

Mountain if it is at all feasible to do so. PV arrays for several of the RT sites may need to be located a short distance away from the actual monitoring and communications equipment in order to avoid excessive terrestrial shading. Only a proper site survey can determine whether adequate sites are available near each of the RT sites. Optimal layout of a distributed PV system should lead to substantial cost savings in comparison with the centralized system considered in the report. The cost savings include:

## 26 | Power Sources for Remote Arctic Applications

fewer total solar panels needed, smaller power inverters and power conditioning equipment needed, and much less transmission cable needed. For the purposes of this background paper, it is assumed that a distributed configuration could be used for a PV energy system installation at Burnt Mountain.

### Stand-Alone PV Power System (PV/Battery)

A stand-alone PV power system would require large battery banks for storage through the dark months of November through February, and PV arrays large enough to both run the equipment and recharge the batteries during the period when maximum solar resources are available. These facts make battery design a critical component of a successful stand-alone PV system, but there are no technical barriers to the design of such a system. Due to the northern location of the installation, batteries become a much more dominant component of the overall system than in most remote PV applications.

A battery backup system would entail delivery of a large volume of batteries to the site. The actual amount would depend on the type of battery used. In addition, the PV panels would need to be sized large enough to recharge the batteries in the summer in addition to providing the power needed directly to seismic equipment. The Air Force estimates that 95,000 pounds of batteries would be needed for this service. The estimate is based on the use of lead-acid batteries. In addition, it assumes that these batteries cannot be discharged any more than 20 percent without the risk of freezing. This means that the battery storage must be five times the amount of energy to be used from the batteries. Under these assumptions, approximately 40 helicopter trips would be needed to transport the fully charged batteries to the site for the initial installation.

It is recommended by Northern Power Systems--one of the leading companies involved in the design and implementation of PV energy systems for cold-weather applications--that nickel-cadmium (NiCd) batteries be given serious consideration for use at Burnt Mountain. NiCd batteries cost more than conventional lead-acid batteries, but they have a longer lifetime, and deliver much higher performance under cold-weather conditions with less maintenance requirements. They have a higher power density (power per pound of battery) and they can be discharged more deeply (up to 80 percent). This would yield substantial savings in the transport of the batteries to the site. Another advantage of NiCd batteries is that they require much less maintenance than conventional lead-acid batteries. Over the 30-year expected operating life of the Burnt Mountain Observatory, the batteries will probably have to be replaced one time, instead of twice for the conventional lead-acid batteries.<sup>6</sup>

NiCd batteries are not without disadvantages, though. An accidental release of cadmium would present potential environmental problems. Cadmium is classified by the Environmental Protection Agency as one of the 17 most dangerous substances if released into the environment.

The batteries probably could be housed in the existing shelters, and with adequate insulation it should be possible to maintain the batteries without a requirement for external heating. It is possible that the battery cost could represent as much as 50 percent of the total installed cost of a PV energy system for Burnt Mountain.

Overall system reliability could be enhanced by making, when necessary, a service call to the site in late October to booster charge the batteries with portable generators for the winter haul. This could be performed in years for which

---

<sup>6</sup>Sealed lead-acid batteries with 20-year lifetimes are now available. Like NiCds, these would only have to be replaced once.



cloudier than normal conditions persist during the summer months. Remote monitoring of battery charge levels should be easy to accomplish.

A stand-alone PV power system for the Burnt Mountain Seismic Observatory would consist of five separate, isolated installations. Each of the installations would include two to three PV panels, support structures, power conditioning equipment, and NiCd storage batteries designed for seasonal power storage. Each PV panel, rated at 50 to 60 watts peak, would measure less than 1 square meter in surface area. Four of the installations would be designed to serve continuous loads of 10 watts and peak loads of 150 watts each. The fifth installation would be designed to serve a continuous load of about 30 watts and a peak load of 150 watts.

Actual PV system costs for such an installation can only be determined by performing a site survey, resource assessment, and preliminary engineering. The regular rule of thumb used in the industry for estimating PV system installed costs for complete systems including batteries is \$10 to \$15 per installed peak watt of capacity. This rule of thumb covers systems designed for conventional applications, and for sites that do not experience prolonged dark periods. The much larger and more sophisticated batteries needed for an application like Burnt Mountain mean that actual system costs would be much higher than conventional PV systems.

### **Hybrid Power System (PV/TEG)**

The alternative to designing a system with adequate battery storage to allow for 100 percent solar energy production is to utilize a hybrid system, in which power during the dark period and other prolonged periods of unavailability of solar insolation is provided by an alternative power source. Propane-fueled TEG power systems are the primary candidate to act as the supplemental power source. The use of a hybrid system, in comparison with a PV/battery system, allows substantial savings in terms of re-

duced battery and PV panel size requirements, as seasonal storage is no longer necessary. However, a more complicated control system is required.

However, it also means transporting propane, though a smaller amount than in the TEG alone option. In addition, there would need to be an automatic control system to start the TEG when PV power output was too low. The reliability of such a control system is a concern, especially its cold starting performance.

In a hybrid PV/TEG system for Burnt Mountain, the TEG component of the system would be sized large enough to carry the load fully during the dark period. Each of the remote RT sites (U1, U2, U4, and U5) would require about a 15 watt TEG, while the U3 site, which would carry the ROF load as well as the RT load, would require about a 40 watt unit. The five TEG units would be expected to operate for approximately 2,200 hours per year (one-quarter of the year), using approximately 1,250 pounds of fuel per year, which is about 250 gallons per year. This is one-quarter as much fuel as would be used by a stand-alone TEG power system.

The use of a PV/TEG hybrid power system in a distributed configuration would require the installation of storage tanks for propane fuel and compressed nitrogen at each of the five RT sites at Burnt Mountain. Nitrogen would be required for forcing fuel to the TEG units under the very cold weather conditions that are known to occur regularly during the dark period at the Burnt Mountain site. Electric ignition and flame stabilization would also be required for the TEGs, which would be depended on for operation of the observatory during the most severe weather conditions of the year, when site maintenance is almost impossible.

### **I Reliability**

PVS are able to provide the required level of electric service reliability because they are entirely passive in their operation and have no

moving parts. In addition, with a PV system, the observatory's equipment would be powered directly by the battery system, not the PV module itself. The battery system is passive in operation as well, and does not employ any moving parts. It should be easy to install a remote monitoring capability for the battery charge levels as part of a PV power system, in order to allow monitoring of battery performance by the Air Force Technical Applications Center.

Of the three PV system packagers contacted for this background paper, two favor the use of a stand-alone PV system for Burnt Mountain, and the other favors the use of a hybrid PV/TEG system. OTA's analysis indicates that a stand-alone PV/battery system has lower cost, greater operational simplicity, and lower environmental impact. For these reasons, this background paper concludes that a stand-alone system should be given priority in testing and installation.

After the initial period of insolation and weather data collection, several PVS should be operated side-by-side with the RTGs in order to establish their operating reliability and their resistance to windloading and snow and ice buildup. Also, the annual service calls to the Burnt Mountain Observatory site should include full service for the PV energy system. PV service should include annual maintenance on the battery system, as well as cleaning of the PV module and checking of the module's support structure, wiring, and control systems.

In cases where a module has not received sufficient insolation during a given summer period to store up enough charge for the winter run, a portable generator could be brought in to booster charge the battery for continued reliable operation of the system. However, since transporting materials and equipment to Burnt Mountain is costly and logistically challenging, the PV system should be designed (sized) so that booster charging is required only in extremely rare instances. Under these conditions, a PV power system should be able to deliver the desired level of reliability.

### **SUMMARY OF COSTS AND RELIABILITY**

RTGs have proven very reliable power sources for the Burnt Mountain Observatory. The costs of keeping them operating include annual leak testing trips (which are accomplished in conjunction with electronics maintenance trips) and the \$1,500 annual license fees. There will be substantial costs to moving the RTGs from Burnt Mountain whenever they reach the end of their lifetime.

TEGs are also reliable. There is some concern about their cold starting capabilities, but insulation and line burial should minimize problems in this area. The Air Force estimates that the installation costs would be between \$430,000 to \$880,000 depending on the configuration (table 4-3).

PV power systems are commercially proven technologies for supplying the type of power needed at Burnt Mountain. PV systems currently provide power for remote, unattended applications in polar Alaska and Antarctica. The Air Force estimates that the installation costs would be about \$1 million, owing to the cost of laying the power distribution system and the large volume of batteries required. These costs could be considerably lower if a distributed configuration and NiCd batteries were used. Moreover, there are no refueling requirements. Annual maintenance requirements would be low, but periodic replacement of batteries and possibly PV panels would be necessary.

It should be relatively easy to integrate a PV power system into the existing equipment and electrical configuration at Burnt Mountain, as PV modules and battery systems produce electricity in similar form--DC--and voltage to the existing RTG power system. It may be desirable to electrify one RT site with a PV system and operate it for a year or so while the existing RTG system is in place. This approach would help to demonstrate the reliability of the technology prior to removal of the RTGs from Burnt Mountain.

Chapter 4 Power Source Equipment: Cost and Reliability I 29

**TABLE 4-3: Summary of Costs of TEG and PV Power Sources as Estimated by the Air Force (thousands of dollars, 1994)**

	<u>TEG</u> (central)	<u>TEG</u> (distributed)	<u>PV</u> (central)
<b>Installation</b>			
Equipment	\$49	\$69	\$203
Airlift of equipment and fuel	90	104	177
Installation of equipment	192	181	66
Installation of power lines	393		393
Management and engineering	156	76	180
Subtotal	\$880	\$429	\$1,020
<b>Replacement (once)</b>			
Equipment (TEGs PV arrays)	49	69	7
Airlift of equipment			26
Management and engineering			7
Subtotal	49	69	41
<b>Replacement (twice)</b>			
Equipment (batteries)			\$114
Airlift of equipment			98
Management and engineering			46
Subtotal	0	0	\$257
<b>Annual</b>			
Fuel	\$10	\$8	
Airlift of fuel	23	21	
Miscellaneous supplies (29 years)			15
Management and engineering	7	6	3
Subtotal	\$39	\$3-1	\$18
<b>Total present value*</b>	<b>\$1,110</b>	<b>\$632</b>	<b>\$1,207</b>

KEY: TEG = thermoelectric generator, PV = photovoltaic.

@ Calculated at a discount rate of 15 percent

NOTE: Cost estimates based on 30-year lifetime of service

SOURCE: Wright laboratory, Aeropropulsion and Power Directorate, Aerospace Power Division, "Power System Assessment for the Burnt Mountain Seismic Observatory, " report prepared for the Air Force Technical Applications Center, May 1994. Data is from Tables 2.1.7-1, 2.2.7-1, and 227-2

# Power Source Equipment: Safety and Environmental Assessment | 5

**T**he safety and environmental characteristics of the radioisotope thermoelectric generators (RTGs) and alternative power systems for the Burnt Mountain Seismic Observatory are of paramount importance. In their letter to the Office of Technology Assessment (OTA), Senators Stevens and Murkowski identified the following as the primary evaluation criteria of the power system:

... the health and safety of the nearby population, the health and safety of Air Force Technical Applications Center (AFTAC) maintenance and transportation technicians, and the environmental impacts to the surrounding area, including anticipated or potential emission of effluents to the environment. (Areas surrounding the site are important wildlife habitat and subsistence hunting and trapping areas for local populations.)

This chapter examines the three most viable power generating systems under consideration for the Burnt Mountain Seismic Observatory: the existing RTGs, propane-fueled thermoelectric generators (TEGs), and photovoltaic (PV) power systems. The focus is on the safety and environmental impacts associated with potential accidents at the site. The risks connected with the routine deployment and operation of the candidate power systems are smaller and therefore given little attention. The accident scenarios that were examined include offsite fire, earthquake, vandalism, aircraft crash, and transportation of the RTGs out of the site or propane fuel into the site.

The risk analysis in this background paper is limited in scope. The accidents' initiating events and the associated critical pathways to environmental and safety problems are analyzed qualitatively. O TA did not attempt to calculate actual probabilities for the initiating events or the various potential pathways in the accident chain of events. Thus, this paper can only comment on possible events that could cause damage, but cannot compare actual risks.

## **RADIOISOTOPE THERMOELECTRIC GENERATORS**

The "fuel" for RTGs, strontium-90 (Sr-90), is the main source of environmental risk associated with the RTGs. The radiation and toxicological characteristics of Sr-90 are discussed in chapter 2. It should be reiterated that Sr-90 is not an explosive material. The fuel, Sr-90, is present in the form of a

## 32 I Power Sources for Remote Arctic Applications

ceramic material: strontium-titanate ( $\text{SrTiO}_3$  or  $\text{Sr}^2\text{TiO}_4$ ). This material was selected in large part for its fire resistance and low water-volubility properties. In an RTG, the fuel is encased in cladding and a capsule, and then surrounded by a radiation shield made of tungsten. The radiation shield is surrounded by thermal insulation and encased in a metal housing. RTG fuel capsules have passed stringent heat, thermal shock, impact, and projectile striking tests without developing any detectable leaks of the radioisotope material. Engineering analyses have been conducted on RTG “packages” to demonstrate their accident resistance during transportation.

### ~ Licenses and Emergency Plans

RTGs are covered by various federal regulations governing the use, transport, and disposal of radioactive materials. The Air Force Technical Applications Center (AFTAC) maintains the Quality Assurance Program (QAP) No. 0772, Revision O for the RTGs at Burnt Mountain. The QAP is necessary to keep (or obtain) Certificates of Compliance (COCs) from the Nuclear Regulatory Commission (NRC). COCs are necessary for transport and upgrade modifications of RTGs. In the future, AFTAC will pay approximately \$1,500 per year for administration of the QAP.<sup>1</sup>

The RTGs used at Burnt Mountain were originally licensed via the NRC licensing process. In 1981, the Alaska Department of Health and Social Services confirmed its awareness of the RTGs at the station. When additional RTGs were requested in 1985, a public meeting was held in Fort Yukon.

Current use of the Burnt Mountain RTGs is covered by U.S. Air Force (USAF) Radioactive Material Permit No. 09-30272 -IAFP issued by the USAF Radioisotope Committee, whose authority is granted by NRC Master Materials License No. 42-23539 -OIAF. This permit, which was renewed for the period January 29, 1992 through October 31, 1994, covers a wide range of nuclear materials, not just the RTGs, used by AFTAC. The permit stipulates that the RTGs must be tested for radioactive leakage and/or contamination at least once every 12 months. The previous permit required that the RTGs be leak tested once every six months. This was changed because of the remoteness and difficulty of getting to the site. A threshold of 0.005 microCurie per 100  $\text{cm}^2$  is used to indicate a leaking source. The RTGs at Burnt Mountain have always tested at levels below 0.00005 microCurie per 100  $\text{cm}^2$ , the detection threshold of the laboratory procedure.<sup>2</sup> The permittee must report each year to the USAF Radioisotope Committee on the containment (leak test) status of the RTGs and present evidence that the manufacturer’s recommended operating temperature has not been exceeded.

All RTGs are designed to comply with the following standards for radiation dose rates during routine operation and transportation and for radiation containment during potential transportation accidents:

- **During operation, allowable radiation dose rates are** stipulated in Title 10 of the Code of Federal Regulations (CFR), Part 20, which is enforced by NRC. The threshold amounts of

---

<sup>1</sup>until recently, Teledyne Isotopes, Inc., the manufacturer of the Sentinel RTGs, maintained the OAP and held the COCs for the RTGs at Burnt Mountain. Those certificates and the associated responsibilities have been transferred to the Air Force.

<sup>2</sup>Though Sr-90 emits only beta particles, these standard assays measure alpha and gamma levels as well as beta levels. Typical readings in 1991 were: gross alpha activity at less than 0.000002 microCurie per 100  $\text{cm}^2$ ; gross beta activity at less than 0.000001 microCurie per 100  $\text{cm}^2$ ; and gross gamma activity at less than 0.00005 microCurie per 100  $\text{cm}^2$ . Over the years, the RTGs have on occasion tested higher than these levels, but have always been well below the threshold indicating leakage. In 1992, the gamma assays were discontinued.

radiation in unrestricted areas are levels which, if a member of the general public were continuously present in the area, could result in his receiving a dose in excess of: 2 millirem in any one hour, 100 millirem in any seven consecutive days, or 0,5 rem in a year.<sup>3</sup>

. During transportation, allowable radiation levels are prescribed in Title 49 of the CFR, Part 173, Subpart I, which is enforced by the Department of Transportation (DOT). If the RTG "package" emits radiation in excess of 200 millirem per hour at any point on its exterior and emits more than 10 millirem per hour at 3.3 feet (1 meter) from any accessible external surface, it must be shipped in a transport vehicle (except aircraft) assigned for the sole use of the consignee and must meet other restrictions.

. **For potential accidents, radioactive material containment** is covered by Title 10 of the CFR, Part 71 and Title 49 of the CFR, Part 173, Subpart I, and is enforced by NRC and DOT, respectively. These provisions set performance criteria that packages used for the transportation of radioactive material must meet for conditions of heat (fire), impact, percussion, thermal shock, pressure, and leakage resistance. Similar standards are required by the International Atomic Energy Agency (IAEA) Safety Series 33 guidelines for the safe design, construction, and use of RTGs. Under these provisions, the fuel capsule must retain its original leak tightness in the following: 1) *heat (fire) test* in which the fuel capsule is heated to 800°C (1472°F) for 30 minutes; 2) *impact test* in which the fuel capsule is dropped 9 meters (29.5 feet) onto a flat, con-

crete supported steel plate; 3) *percussion test* in which the fuel capsule is struck by a steel billet with an impact equivalent to 7 kg (15.4 pounds) falling a distance of 1 meter (3.3 feet); 4) *thermal shock test* in which the fuel capsule is heated to its maximum operating temperature and then plunged into 0°C (32°F) water and submerged for 10 minutes; and 5) *pressure test* in which the fuel capsule is subjected to an external pressure of 14,500 psi.

An assessment of the potential environmental impact of the use of RTGs was completed in 1973 and revised in 1977 by Weiner Associates for the Naval Facilities Engineering Command.<sup>4</sup> The document examined normal transportation and operation of RTGs on land as well as ocean bottom and surface/near surface locations. It concluded there were no adverse environmental impacts associated with the transportation and operation of RTGs covered by the Navy's NRC license. It found that the radiation levels for the RTGs as packaged for shipment did not exceed the 200 millirem per hour at the surface and the 10 millirem per hour at 3 feet from the surface criteria. Based on tests of a Sentinel model 100F fuel capsule, the RTGs were found to comply with all IAEA Safety Series 33 tests for resistance to impact, percussion, heat, thermal shock, pressure, and leakages. An extensive engineering evaluation of the resistance of RTG housings to transportation accidents was also performed (on a different model RTG, a SNAP-21). Accidents, such as a head-on collision with another truck, total burial in earth, chemical attack, truck-train collisions, and fires were evaluated. It was concluded that the impact energy from a head-on

---

<sup>3</sup>An unrestricted area is any area that is not controlled by the licensee for purposes of protection of individuals from exposure to radiation and radioactive materials, and any area used for residential quarters.

<sup>4</sup>Weiner Associates, Inc., "An Environmental Assessment for the Use of Radioisotope Thermoelectric Generators," project WAI-104, report prepared for the Department of the Navy, Naval Facilities Engineering Command, Nuclear Power Division, May 1973 and revised May 1977.

<sup>5</sup>The tests were performed by the U.S. Naval Ordnance Laboratory.

## 34 | Power Sources for Remote Arctic Applications

collision could rupture the RTG housing and biological shield, but that the fuel capsule would survive.

The methods of removal of the RTGs from Burnt Mountain and their disposal are uncertain. Since the RTGs contain high-level nuclear material, there is currently no permanent disposal site that will accept them. They would have to be kept at a temporary storage site such as the Hanford facility in Washington until a permanent disposal site could be located. AFTAC has the required Certificates of Compliance and the Air Force has an NRC license that allows them to "permit" the receipt, storage, use, and transportation of the RTGs under specific conditions. No additional approvals from NRC are required to move the RTGs from Burnt Mountain.

The Air Force has an emergency procedures plan in case of a suspected radiological accident at Burnt Mountain. The procedures are executed whenever there is an interruption in the data coming from the site. The first step is to check the integrity of the communications electronics, because loss of data may or may not be caused by problems with the RTGs. If needed, a helicopter can be sent to the site or flyovers can be scheduled for quick damage assessment. The plan includes procedures for tending to any people at the site and notification of Air Force commanders, rescue teams, and radiation safety personnel.

### 1 Accident Scenarios

OTA has examined five accident scenarios for RTG power systems. The scenarios are identified by their initiating events: offsite fire, vandalism, earthquake, aircraft crash onto the Burnt Mountain site, and transportation of the RTGs out of the Burnt Mountain site. The first four scenarios cover accidents possible during the continued operation of the RTGs, while the fifth scenario encompasses the risks of removing the units from Burnt Mountain. It must be noted that the units will need to be removed and disposed of at some time--at the latest when the observatory itself is taken out of service. Of course, operating RTGs at Burnt Mountain for another 20

years or so, as envisioned by the Air Force, reduces by nearly half the radioactivity of the Sr-90 that must be transported. The amount of radioactive material, however, does not decrease over this period.

Four accident scenarios--those initiated by offsite fires, earthquakes, vandalism, and the crash of an aircraft directly into a power-system enclosure at the Burnt Mountain site--have similar event pathways. However, the relative probabilities of the various events for each initiator can vary. Following the initiating event, the potential sequence of events leading to exposure of the nuclear material to humans is as follows: breach of the RTG housing, breach of the radiation shield, breach of the fuel capsule, air dispersal, water dispersal, and soil contamination. Plant uptake is highly unlikely because the strontium is bound in a ceramic with very low volatility. Unless the accident compromises the radiation shield, there is no environmental or health impact from the event. If the radiation shield is breached, but the fuel capsule remains intact, the problem is principally one of worker exposure to radiation. Environmental contamination or exposure of people (such as hunters) unaffiliated with the station to radiation could occur only if the exposed fuel capsule is not removed promptly after the radiation shield is breached, or both the radiation shield and fuel capsule are breached. Even if both of these containment layers were breached, contamination would only occur in the event of air dispersal or water dispersal. Given the stable nature of the strontium titanate and the cleared area around the sites, these events are very unlikely. More probable in the event of a containment failure is localized soil contamination. This would be a problem primarily for workers charged with cleaning up after the accident.

### *Fires*

It is known that forest fires can impinge on the Burnt Mountain Seismic Observatory site. A fire in the summer of 1992 encroached on the site, but did little damage to the power system enclosures or any part of the power systems. A

future fire could sweep across the observatory site, consuming one or more of the structures housing the RTG power generating units. In the worst case, it might be possible that an RTG unit might fall over, strike the ground, and then be exposed to fire.

RTGs have been designed to withstand both shocks (e.g., by dropping) and fires without the release of any of the radioisotope fuel. The probability of the RTG unit breaking upon a fall within the enclosure, or as a result of debris falling as the enclosure burns, is extremely small. At worst, the outer casing might crack, and the radiation shield might crack, but the probability of the fuel capsule itself being breached is smaller still. RTG fuel capsules have been tested by dropping them 9 meters onto a flat, very hard surface, without any detectable radiation leak. No conceivable impact of that magnitude could be imagined in the event of a fire.

Temperatures in the hottest of forest fires can exceed 2,000°F. This is hot enough to melt some metals, possibly including the ones in the housing of the RTG units at Burnt Mountain. This temperature would have no effect, however, on either the radiation shield or the fuel itself. Tungsten has a melting point of 6,179°F; SrTiO<sub>3</sub> and Sr<sub>2</sub>TiO<sub>4</sub> have melting points of 3,704°F and 3,380 ± 36°F, respectively.<sup>b</sup> The heat of a 2,000°F forest fire would not melt or volatilize any of the radioisotope fuel contained in the RTGs at Burnt Mountain. Indeed, there is very little risk that any combination of impacts and heat exposure that could be experienced by an RTG in a worst-case forest fire would cause a release of the radioisotope fuel from the units. Even a breach of the radiation shield is extremely unlikely, and could only be the result of an impact. A breach of the radiation shield might present a risk of radiation exposure to the workers involved in the cleanup that would follow a fire,

but little risk to others. Worker exposure can be minimized using standard industry practices.

### **Earthquakes**

Earthquakes and most vandalism scenarios for accidents to the RTGs at Burnt Mountain present mainly risks of various types of impacts to the RTG energy systems. In the case of an earthquake, the risks are that the RTG units will fall over, and that the power system enclosures will collapse on them. Even in the worst case earthquake, it would appear that the chances of breaching the biological shield are extremely small, and the chances of breaching the fuel capsule are smaller still. Cleanup from an earthquake would probably be easier and safer than cleanup from the worst-case fire.

### **Vandalism**

Vandalism of the RTGs can be divided into two categories: casual vandalism and dedicated vandalism. Casual vandalism is defined as the types of acts that might be committed by people passing through the site for other purposes, not prepared beforehand to assault the RTGs. Dedicated vandalism is defined as terrorist acts planned and carried out against the RTGs. Acts of casual vandalism might include the shooting of hunting rifles at the RTGs, and attempts to dislodge and move the RTGs from their fixed positions in the enclosures. Acts of dedicated vandalism might include deliberate burning of the shelters and dynamiting of the RTGs.

### **Casual vandalism**

No conceivable act of casual vandalism would cause a breach of the fuel capsule or a leak of the radioisotope from the RTGs. Penetration of the radiation shield is also highly unlikely, and would present only slight risks for maintenance and repair workers. In fact, it is unlikely that the

---

<sup>b</sup>S. J. Rimshaw and E. E. Ketchen, *Strontium-90 Data Sheets*, ORNL-4358 (Oak Ridge, TN: Oak Ridge National Laboratory, 1969).



## 36 | Power Sources for Remote Arctic Applications

shooting of a bullet into an RTG would have any impact on its operation. It is also unlikely that casual vandals would be able to dislodge the RTGs from their moorings, as the smallest of the RTG units at Burnt Mountain weighs approximately three-quarters of a ton. Even if a unit were knocked over, it is unlikely that any damage to the housing or its contents would result. Thus, casual vandalism presents virtually no radiation risk at the Burnt Mountain Observatory.

### **Dedicated vandalism**

For RTG accidents caused by offsite fires, earthquakes, and casual vandalism, breach of both the radiation shield and the fuel capsule of an RTG and release of radioisotope material is highly improbable. However, in the case of dedicated vandalism, the situation might be different. It might be possible for a sophisticated terrorist to bring sufficiently high-powered explosives to the Burnt Mountain site to damage and breach the radiation shield, and possibly the fuel capsule as well. In the event of a breach of the radiation shield, but not the fuel capsule, the major risk would be to cleanup workers who would recover the capsule for removal and disposal. In the event that the fuel capsule itself is breached, the radioisotope material would be exposed to the environment. It is unlikely that there would be substantial airborne dispersal, as the Sr-90 would remain bound in the form of solid strontium titanate. The titanate might break apart, but most of the particulate would be large, and thus would be likely to fall no farther away than the other debris from the explosion. The range of dispersal would depend on the power of the explosion. If the strontium titanate is released, some soil would be contaminated. However, strontium titanate is highly insoluble, so it would not tend to migrate deep into soils, nor contaminate waterways in dissolved form. Water runoff in the event of a rainstorm following an act of vandalism could carry and disperse some of the material away from the site. Due to the biological unavail-

ability of the titanate fuel form, plant uptake of Sr-90 and entry into the food chain would be minimal.

### ***Aircraft and Transportation Accidents***

If a decision is made to phase out the RTGs soon, or in any case at the end of the useful life of the Burnt Mountain Seismic Observatory, it will be necessary to remove them from the site. The Air Force expects that the units will be moved by helicopter out of Burnt Mountain, with eventual storage at the Hanford site in the state of Washington. Handling accidents with the RTGs at the Burnt Mountain site should not be a problem. The major sources of risk considered are helicopter flight accidents and crashes. Both types of accidents present risks of breaching the radiation shield and the fuel capsule containing the Sr-90 fuel. The possible sequence of events following a breach of the radiation shield and/or fuel capsule are the same as those discussed above.

The two major risks to the integrity of the RTG in the event of a helicopter accident are:

- . the explosive force of a major fuel explosion, either in mid-air or on impact with the ground; and
- . the impact force of the entire RTG unit or the fuel capsule falling a long distance from an airborne helicopter,

The force necessary to breach the RTG housing and radiation shield would be considerably less than that needed to breach the fuel capsule itself. This is so for two reasons: first, the metal casing and tungsten radiation shield would absorb much of the energy, shielding the fuel capsule; and second, the fuel itself is encased in stainless steel and a very ductile and rupture-resistant nickel alloy, Hastelloy C. If the fuel capsule remains intact, it presents a radiation risk mainly to cleanup workers, who would recover it for proper disposal. If the capsule is breached,

the radioisotope material would be exposed to the environment. In no event would there be any melting of the ceramic fuel material-strontium titanate-although some of the fuel could crumble, especially in the case of the explosion scenarios. It is unlikely that a substantial fraction of the strontium titanate would be converted into fine particulate, so in the event of a ground-level breach of the capsule, the great bulk of the material would fall out within a short distance of the accident. An explosion in the sky could cause a much wider dispersal of the material.

All of the dispersed radioisotope material will remain in the form of the ceramic material strontium titanate, which is highly resistant to dissolving into water, and relatively inert with respect to uptake by plants. Most of the contamination near a ground-based accident should be able to be recovered by a cleanup crew. The remainder of the material would present a risk mainly to animals that come into close contact with it, as the beta radiation travels no more than about 10 inches through the air. In addition to the risk of helicopter accidents during an RTG removal trip, there is also the risk of a helicopter crashing into an RTG at Burnt Mountain during a routine maintenance and inspection trip. The sequence of events following the impact of a crash would be the same as that following an RTG removal accident.

### **PROPANE-FUELED THERMOELECTRIC GENERATORS**

Delivery, handling, and storage operations for the propane fuel for TEGs are the main source of environmental risk associated with the use of TEGs at the Burnt Mountain Observatory. Propane fuel would be stored in onsite tanks that could be either buried or installed above ground. Fuel would have to be brought to the site from Fort Yukon, some 50 miles away, by helicopter. Access by land is difficult, even via all-terrain vehicle, because there are no roads and the tundra is fragile. The tanks must be able to store more

than a year's supply of fuel in order to allow refueling to be accomplished on an annual basis. Semiannual refueling operations may also be considered. A system of piping and valves delivers the propane from the fuel tank to the combustor, which is part of the generator unit. TEGs and propane storage tanks are designed to be safe from damage by dropping and fire.

Propane is a high-volatility hydrocarbon fuel that can be liquefied at ambient temperature under moderate pressure conditions. It is stored and handled in liquid form. The major environmental risks associated with propane fuel are fire and explosions. Propane is not considered to be a toxic substance, and any material spilled that is not burned will evaporate into the atmosphere. The boiling point of propane at atmospheric pressure is -44°F.

Four accident scenarios are examined for TEG power systems. The scenarios are identified by their initiating events: offsite tires, vandalism, fuel transportation and handling, and equipment and material transportation and construction. The first three of the scenarios cover accidents that could occur to the TEG energy systems during their operation and maintenance. The fourth scenario involves the environmental risks encountered during the project implementation phase of installing the TEG energy systems. Transportation and construction risks are similar to those that would be encountered with the implementation of any new energy system at Burnt Mountain.

The major source of environmental risk for the TEG energy systems is the heat source. Propane, a hydrocarbon fuel, is highly volatile and flammable, and in some conditions, explosive. It is stored under pressure in order to maintain it as a liquid, so it tends to escape quickly in the event of a leak. The only real concerns about the use of propane fuel at Burnt Mountain are in connection with fires and explosions. Fuel that escapes but does not burn will simply evaporate and dissipate in the atmosphere. The small

## 381 Power Sources for Remote Arctic Applications

amounts of fuel that will be stored onsite at any one time should not be a concern with regard to regional atmospheric hydrocarbon pollution,

### **I Accident Scenarios** **Fires**

In the event of a major offsite fire, it is possible that both the fuel lines and above-ground fuel tanks would fail, even though they would be designed to withstand such conditions. At the least, the onsite fuel would be consumed in the fire; at worst, there could be an explosion. Burial of the fuel tanks would help to lessen the probability of a major explosion, although it would entail increased environmental disruption at the site due to the need for digging into and disrupting the permafrost.

The presence of propane fuel at the Burnt Mountain site would increase the risk of damage to the seismic sensing facility in the event of a marginal fire encroaching on the site, including possibly a fire similar to the one that passed through the area in the summer of 1992. Should there be a breach of either a fuel line or storage tank, the presence of propane fuel at the site could spread the fire further than it would otherwise go, and/or cause explosive damage that would not otherwise occur.

### **Vandalism**

Casual vandalism at the Burnt Mountain Observatory could cause a rupture of either the fuel lines or fuel tanks at the site, resulting in the release of propane fuel and system shut down. The leaking fuel would then present a substantial risk of fire and explosion, depending in large part on the presence of a spark or other ignition source. The ignition source could be supplied by either the vandal, the site's existing power system, or another natural source. Propane is very easily ignited, and explosive at low concentrations in the air. If the propane leaks away without ignition, it

will simply evaporate and disappear, causing no toxic effects at the site, and leaving no residuals onsite,

### **Delivery and Handling of Propane**

The propane fuel must be flown to the Burnt Mountain site via helicopter from the Air Force's staging area in Fort Yukon, more than 50 miles away from the seismic observatory. Each step in the fuel delivery process—handling at Fort Yukon, inflight transportation, and handling at Burnt Mountain—entails some risk of fire and explosion. Standard safety practices have been established for handling and using propane fuel—indeed propane is safely used and transported in a wide variety of everyday situations, but residual risks would remain at each step.

Two different configurations are under consideration for TEG deployment at the Burnt Mountain Observatory: 1) a centralized configuration in which the TEGs are installed near the U3 site, where the data multiplexer and transmitter are currently located, and a power distribution network must be installed in order to deliver power to each of the remote terminal (RT) sites, and 2) a distributed configuration equivalent to the current RTG power system, in which TEGs are deployed at each of the RT sites, and no electricity distribution system is required. The central-generator configuration would consume approximately 25 percent more fuel than the distributed configuration because of the need to cover electricity distribution losses, and bringing in this much additional fuel would increase the risks of fuel supply accidents by some increment. However, deployment in a distributed configuration would require fuel to be distributed on the ground to each of the RT sites from the central heliport staging area, which would present an entire set of risks that do not pertain to the central power-generating configuration.

### **Deployment of a TEG Power System**

The deployment of a TEG energy system at Burnt Mountain entails environmental risks. All of the material needed for the deployment of the system must be flown in by helicopter, including the TEG generators and the tankage, as well as all pertinent parts and equipment. Each helicopter flight entails a level of risk, both in flying to the Burnt Mountain site and in landing at the site. The distribution of equipment and material at the site would entail risk of environmental disruption, as would installation operations, particularly the installation of the fuel tanks. The configuration used for the TEG systems would have a major influence on the types of onsite environmental impacts that are of concern. With a distributed configuration, there would be installations of generators and fuel tanks at each of the five RT sites. With a centralized configuration, there would be only one power system installation, but this configuration would also require the installation of the power distribution system.

### **PHOTOVOLTAICS**

PV energy systems present minimal risks for safety and the environment under routine operating and maintenance conditions. During the transportation and construction phases of deploying a PV system at Burnt Mountain, the risks are similar to those of TEGs. There are also safety and environmental risks associated with damage to the batteries in PV systems caused by transportation accidents, fires, and bullets—shot either accidentally or with malicious intent. Breach of the batteries could release toxic fumes and lead, nickel, cadmium, or other heavy metals into the environment. These heavy metals pose a variety of environmental health hazards. If they contaminate the air, water, or soil, human exposure might occur through breathing dust, through skin contact with the soil, or through ingestion of water or contaminated plants or animals. For example, breathing cadmium can cause damage to the lungs and kidneys, while long-term exposure to cadmium through ingestion can result in harm to the kidneys and bones. Given the relatively small scale of use of batteries, the low likelihood

of a significant breach and subsequent transport to the environment, and the distance from any local population, these risks are very small. Special attention to the structural integrity of the battery containment vessel could reduce, but not entirely eliminate, the risk of contaminating the surrounding soil and water sources. Additional risk arises if booster charging of the batteries is ever required. This is the risk of a helicopter accident while transporting the fuel for the charging equipment.

### **CONCLUSIONS**

The three power systems (RTGs, TEGs, and PVs) examined in this background paper all incorporate human safety and environmental quality as important design criteria. During routine operation and maintenance, the three systems present little risk to the Burnt Mountain environment and to the safety of maintenance personnel and nearby populations. The safety and environmental risks are also very low in most accident and vandalism situations.

The risk associated with RTGs is the possible exposure of radioactive material (Sr-90) to humans, plants, animals, and the environment. The radiation exposure received from physical proximity to an operating RTG is very low. The RTGs are designed such that radiation levels are less than 10 millirem per hour at a distance of 1 meter from the RTG surface. At the maximum rate of 10 millirem per hour, exposure for 4½ hours would yield a dose equivalent to a typical chest x-ray. Of greater concern is the possible exposure caused by breach of the inner shields of the RTG units and release of Sr-90 into the environment. Natural disasters and most accidents associated with human activities present little risk of such release of radioisotope material to the environment. Dedicated vandalism presents greater risk in this regard, but measures can be taken to lower the risk somewhat. In the event that radioisotope material is released, there will probably be minimal long-range dispersal, so cleanup activities should be able to recover most if not all of the radioisotope. Residual Sr-90 material in the environment will remain in a fairly

## 40 | Power Sources for Remote Arctic Applications

inert form (strontium titanate ceramic), with minimal uptake by plants and incorporation into the food chain.

The risks associated with TEGs are the possible fires and/or explosions connected with propane. Propane is highly volatile and flammable, and is explosive under some conditions. Propane accidents can happen in delivering the fuel to the Burnt Mountain site, and while distributing fuel on the ground at the site. Propane accidents during unattended operation of the observatory can be caused either by natural events, like fires and earthquakes, or by vandalism. The construction

phase of installing a TEG system could also cause environmental impacts at Burnt Mountain, but these could be minimized with proper design.

PV systems, while benign in most respects, are not without safety and environmental risks. With them, the risk is the possible release of toxic fumes and heavy metals from the batteries. Such releases could result from damage to the batteries caused by bullets, fires, or transportation accidents. There are also risks of helicopter accidents in deploying and maintaining a PV system, as there are with other systems.

# **A p p e n d i x A :**

## **Acronyms**

## Appendix-A

# Acronyms

<b>AC</b>	alternating current
<b>AFB</b>	Air Force Base
<b>AFTAC</b>	Air Force Technical Applications Center
<b>CFR</b>	Code of Federal Regulations
<b>Ci</b>	curies
<b>CMOS</b>	complementary metal-oxide silicon
<b>COC</b>	Certificate of Compliance
<b>DC</b>	direct current
<b>Det-460</b>	Air Force Detachment 460
<b>DOT</b>	Department of Transportation
<b>IAEA</b>	International Atomic Energy Agency
<b>NiCd</b>	nickel-cadmium
<b>NRC</b>	Nuclear Regulatory Commission
<b>QAP</b>	Quality Assurance Program
<b>PV</b>	photovoltaic
<b>ROF</b>	remote operating facility
<b>RT</b>	remote terminal
<b>RTG</b>	radioisotope thermoelectric generators
<b>Sr-90</b>	strontium 90
<b>TEG</b>	thermoelectric generator
<b>TEM</b>	thermoelectric module
<b>TTL</b>	Transistor-Transistor Logic
<b>USAF</b>	U.S. Air Force